

# Modular contactors 25 - 32 - 40 - 63 A



Hotel room  
energy-  
enabling units



Garden and night  
lighting



Streetlights  
and car park  
lighting



Bathrooms  
lighting  
control



Office lighting  
control



Pump control

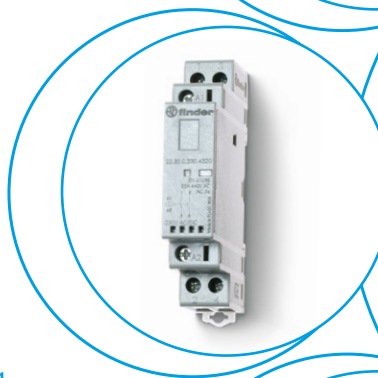

**22**  
SERIES



**25 A modular contactor - 2 pole**

- 17.5 mm wide
- NO contact gap  $\geq 3$  mm, double break
- Continuous duty for the coil and contacts
- AC/DC silent coil (with varistor protection)
- Protective separation (reinforced insulation) between coil and contacts
- Mechanical and LED indicators as standard
- Auto-On-Off selector version available
- AgNi and AgSnO<sub>2</sub> contact versions available
- Compliant with EN 61095: 2009
- Auxiliary contact module available, quick-assembly with the main contactor (1 NO + 1 NC and 2 NO versions)
- For railway applications; materials compliant with fire and smoke characteristics (EN 45545-2 + A1: 2016)
- 35 mm rail (EN 60715) mount

22.32  
Box clamp



For outline drawings see page 14

**Contact specification**

Contact configuration	2 NO, 3 mm* (or 1 NO + 1 NC or 2 NC)		
Rated current/Maximum peak current	A	25/80	25/120
Rated voltage	V AC	250/440	250/440
Rated load AC1 / AC-7a (per pole @ 250 V)	VA	6250	6250
Rated current AC3 / AC-7b	A	10	10
Rated load AC15 (per pole @ 230 V)	VA	1800	1800
Single-phase motor rating (230 V AC)	kW	1	1
Rated current AC-5a (per pole @ 250 V)	A	15	15
Rated current AC-7c	A	—	10
Nominal lamp rating:			
230 V incandescent/halogen W		800	2000
fluorescent tubes with electronic ballast W		300	800
fluorescent tubes with electromagnetic ballast W		200	500
CFL W		100	200
230 V LED W		100	200
LV halogen or LED with electronic ballast W		100	200
LV halogen or LED with electromagnetic ballast W		300	800
Breaking capacity DC1: 24/110/220 V	A	25/5/1	25/5/1
Minimum switching load	mW (V/mA)	1000 (10/10)	1000 (10/10)
Contact material		AgNi	AgSnO <sub>2</sub>
<b>Coil specification</b>			
Nominal voltage (U <sub>N</sub> )	V DC/AC (50/60 Hz)	12 - 24 - 48 - 60 - 120 - 230	12 - 24 - 48 - 60 - 120 - 230
Rated power AC/DC	VA (50 Hz)/W	2/2.2	2/2.2
Operating range	DC/AC (50/60 Hz)	(0.8...1.1)U <sub>N</sub>	(0.8...1.1)U <sub>N</sub>
Holding voltage	DC/AC (50/60 Hz)	0.4 U <sub>N</sub>	0.4 U <sub>N</sub>
Must drop-out voltage	DC/AC (50/60 Hz)	0.1 U <sub>N</sub>	0.1 U <sub>N</sub>
<b>Technical data</b>			
Mechanical life AC/DC	cycles	2 · 10 <sup>6</sup>	2 · 10 <sup>6</sup>
Electrical life at rated load AC-7a	cycles	70 · 10 <sup>3</sup>	30 · 10 <sup>3</sup>
Operate/release time	ms	30/20	30/20
Insulation between coil and contacts (1.2/50 μs)	kV	6	6
Ambient temperature range	°C	-25...+50	-25...+50
Protection category		IP 20	IP 20
<b>Approvals</b> (according to type)			

**22.32.0.xxx.1xx0**



- AgNi contacts, specifically intended for resistive and slightly inductive loads as well as for motor loads

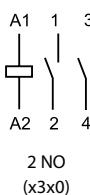

**22.32.0.xxx.4xx0**



- AgSnO<sub>2</sub> contacts, specifically intended for lamp loads and for high inrush current loads

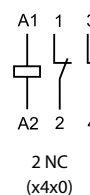
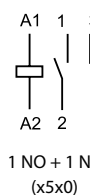

\* Contact gap  $\geq 3$  mm for NO contacts only; NC contacts  $\geq 1.5$  mm

**25 A modular contactor - 4 pole**

- 35 mm wide
- NO contact gap  $\geq 3$  mm, double break
- Continuous duty for the coil and contacts
- AC/DC silent coil (with varistor protection)
- Protective separation (reinforced insulation) between coil and contacts
- Mechanical and LED indicators as standard
- Auto-On-Off selector version available
- AgNi and AgSnO<sub>2</sub> contact versions available
- Compliant with EN 61095: 2009
- Auxiliary contact module available, quick-assembly with the main contactor (1 NO + 1 NC and 2 NO versions)
- For railway applications; materials compliant with fire and smoke characteristics (EN 45545-2 + A1: 2016)
- 35 mm rail (EN 60715) mount

22.34  
Box clamp



For outline drawings see page 14

**Contact specification**

Contact configuration	4 NO, 3 mm* (or 3NO + 1NC or 2NO + 2NC)		
Rated current/Maximum peak current	A	25/80	25/120
Rated voltage	V AC	250/440	250/440
Rated load AC1/AC-7a (per pole @ 250 V)	VA	6250	6250
Rated current AC3/AC-7b	A	10	10
Rated load AC15 (per pole @ 230 V)	VA	1800	1800
Three-phase motor rating (400 - 440 V AC)	kW	4	4
Rated current AC-5a (per pole @ 250 V)	A	15	15
Rated current AC-7c	A	—	10
Nominal lamp rating:			
230 V incandescent/halogen W		800	2000
fluorescent tubes with electronic ballast W		300	800
fluorescent tubes with electromagnetic ballast W		200	500
CFL W		100	200
230 V LED W		100	200
LV halogen or LED with electronic ballast W		100	200
LV halogen or LED with electromagnetic ballast W		300	800
Breaking capacity DC1: 24/110/220 V	A	25/5/1	25/5/1
Minimum switching load	mW (V/mA)	1000 (10/10)	1000 (10/10)
Contact material		AgNi	AgSnO <sub>2</sub>

**Coil specification**

Nominal voltage (U <sub>N</sub> )	V DC/AC (50/60 Hz)	12 - 24 - 48 - 60 - 120 - 230	12 - 24 - 48 - 60 - 120 - 230
Rated power AC/DC	VA (50 Hz)/W	2/2.2	2/2.2
Operating range	DC/AC (50/60 Hz)	(0.8...1.1)U <sub>N</sub>	(0.8...1.1)U <sub>N</sub>
Holding voltage	DC/AC (50/60 Hz)	0.4 U <sub>N</sub>	0.4 U <sub>N</sub>
Must drop-out voltage	DC/AC (50/60 Hz)	0.1 U <sub>N</sub>	0.1 U <sub>N</sub>

**Technical data**

Mechanical life AC/DC	cycles	2 · 10 <sup>6</sup>	2 · 10 <sup>6</sup>
Electrical life at rated load AC-7a	cycles	150 · 10 <sup>3</sup>	30 · 10 <sup>3</sup>
Operate/release time	ms	18/40	18/40
Insulation between coil and contacts (1.2/50 μs)	kV	6	6
Ambient temperature range	°C	-25...+50	-25...+50
Protection category		IP 20	IP 20

**Approvals** (according to type)



**22.34.0.xxx.1xx0**



- AgNi contacts, specifically intended for resistive and slightly inductive loads as well as for motor loads

**22.34.0.xxx.4xx0**



- AgSnO<sub>2</sub> contacts, specifically intended for lamp loads and for high inrush current loads

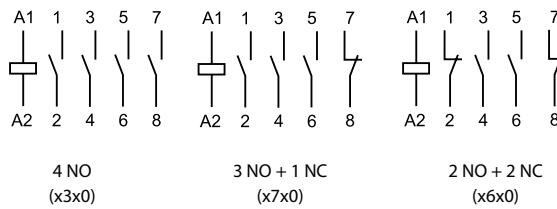

\* Contact gap  $\geq 3$  mm for NO contacts only;  
NC contacts  $\geq 1.5$  mm

**40 - 63 A modular contactor - 4 pole**

- NO and NC contact gap  $\geq 3$  mm, double break
- Continuous duty for the coil and contacts
- AC/DC silent coil (with varistor protection)
- Protective separation (reinforced insulation) between coil and contacts
- Mechanical indicator as standard
- Compliant with EN 60947-4-1 (Mirror Contact) version available
- Auxiliary modules compliant with EN 60947-5-1 (mechanically linked contacts)
- AgSnO<sub>2</sub> contacts
- Compliant with EN 61095: 2009
- 35 mm rail (EN 60715) mount

22.44/22.64

Box clamp



For outline drawings see page 14

**Contact specification**

Contact configuration	4 NO, (or 3 NO + 1 NC or 2 NO + 2 NC or 4 NC) $\geq 3$ mm	
Rated current/Maximum peak current	A	40/176
Rated voltage/Maximum switching voltage	V AC	400/480
Rated load AC1 / AC-7a (per pole @ 400 V)	VA	26000
Rated current AC3 / AC-7b (400 V)	A	22
Three-phase motor rating (400 - 440 V AC)	kW	11
Rated current AC-5a (per pole @ 250 V)	A	20
Rated current AC-7c	A	—
Nominal lamp rating (NO):		
230 V incandescent/halogen W		4000
fluorescent tubes with electronic ballast W		1500
fluorescent tubes with electromagnetic ballast W		1500
CFL W		1000
230 V LED W		1000
LV halogen or LED with electronic ballast W		1000
LV halogen or LED with electromagnetic ballast W		1500
Breaking capacity DC1 (NO): 24/110/220 V	A	40/4/1.2
Minimum switching load	mW (V/mA)	1000 (17/50)
Contact material		AgSnO <sub>2</sub>

**Coil specification**

Nominal voltage (U <sub>N</sub> )	V DC/AC (50/60 Hz)	12 - 24 - 110...120 (110 V DC) - 230...240 (220 V DC)
Rated power AC/DC	VA (50 Hz)/W	6
Operating range	DC/AC (50/60 Hz)	(0.85...1.1)U <sub>N</sub>
Holding voltage	DC/AC (50/60 Hz)	0.85 U <sub>N</sub>
Must drop-out voltage	DC/AC (50/60 Hz)	0.2 U <sub>N</sub>

**Technical data**

Mechanical life AC/DC	cycles	3 · 10 <sup>6</sup>
Electrical life at rated load AC-7a	cycles	100 · 10 <sup>3</sup>
Operate/release time	ms	20/45
Insulation between coil and contacts (1.2/50 μs)	kV	6
Ambient temperature range	°C	See table Current - Temperature derating (page 9)
Protection category		IP 20

**Approvals** (according to type)

**22.44.0.xxx.4xxx**



- For high inrush current loads 176 A
- Contact material AgSnO<sub>2</sub>

**22.64.0.xxx.4xxx**



- Specifically intended: for high inrush current loads 240 A
- Contact material AgSnO<sub>2</sub>

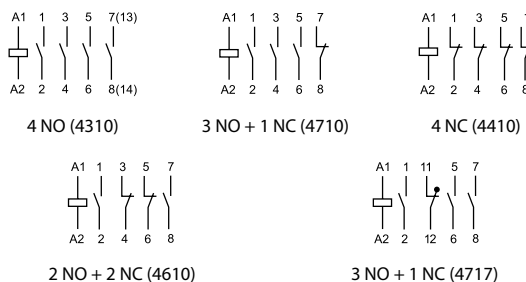

**32 A modular contactor - 2 or 4 pole**

- NO and NC contact gap  $\geq 3$  mm, double break
- Continuous duty for the coil and contacts
- AC/DC silent coil (with varistor protection)
- Protective separation (reinforced insulation) between coil and contacts
- Mechanical indicators as standard
- Compliant with EN 60947-4-1 (Mirror Contact) version available
- AgNi contacts
- Compliant with EN 61095: 2009
- 35 mm rail (EN 60715) mount

22.72/22.74  
Box clamp



For outline drawings see page 14

**NEW 22.72.0.xxx.1x10**



- 17.5 mm wide
- Contact material AgNi

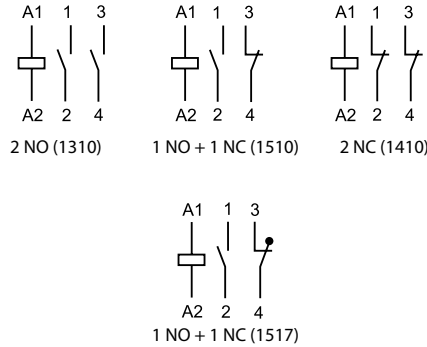

**NEW 22.74.0.xxx.1x10**



- 35 mm wide
- Contact material AgNi

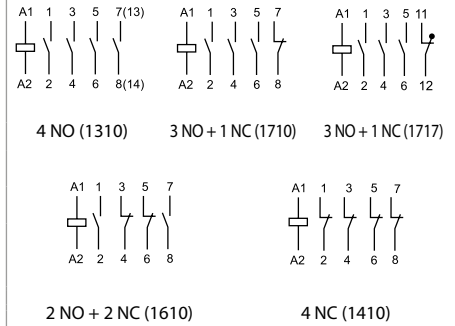

**Contact specification**

Contact configuration	2 NO, 1 NO + 1 NC, 2 NC	4 NO, 3 NO + 1 NC, 2 NO + 2 NC, 4 NC
Rated current/Maximum peak current	A 32/72	32/68
Rated voltage	V AC 230/400	230/400
Rated load AC1 / AC-7a (per pole @ 400 V)	VA 7000/—	7000/21 000
Rated current AC3 / AC-7b (per pole @ 400 V)	A 9 (NO) - 6 (NC)	8.5 (NO) - 8.5 (NC)
Single/Three-phase motor rating	kW 1.3 (NO) - 0.75 (NC) (@230 V AC)	4 (@400 V AC)
Rated current AC-5a (per pole @ 250 V)	A 13	13
Rated current AC-7c	A —	—
Rated current AC15	A 12	12
Nominal lamp rating:		
230 V incandescent/halogen W	2500	2500
fluorescent tubes with electronic ballast W	700	700
CFL W	250	250
230 V LED W	300	300
LV halogen or LED with electronic ballast W	300	300
LV halogen or LED with electromagnet ballast W	500	500
Breaking capacity DC1: 24/110/220 V	A 32/6/0.6	32/6/0.6
Minimum switching load	mW (V/mA) 1000 (17/50)	1000 (17/50)
Contact material	AgNi	AgNi

**Coil specification**

Nominal voltage (U <sub>N</sub> )	V DC/AC (50/60 Hz)	24 - 48 - 110 - 220/24 - 48 - 110 - 230
Rated Power AC/DC	VA (50 Hz)/W	2.1 / 2.6/3.8 (4 NC)
Operating range	AC/DC (50/60 Hz)	(0.85...1.1)U <sub>N</sub>
Holding voltage	AC/DC (50/60 Hz)	0.85 U <sub>N</sub>
Must drop-out voltage	AC/DC (50/60 Hz)	0.2 U <sub>N</sub>

**Technical data**

Mechanical life AC/DC	cycles	10 000 000	10 000 000
Electrical life at rated load AC-7a	cycles	150 000 (NO)/100 000 (NC)	150 000
B10d - AC1 (230 V - 32 A)		150 000	150 000
Operate/release time	ms	45/50	45/70
Insulation between coil and contacts (1.2/50 μs)	kV	4	4
Ambient temperature range	°C	See table Current - Temperature derating (page 9)	
Protection category		IP 20	IP 20

**Approvals** (according to type)

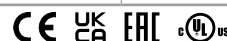

### Ordering information

Example: 22 series, modular contactor 25 A, 4 NO contacts, coil 230 V AC/DC, AgSnO<sub>2</sub> contacts, Auto-On-Off selector + mechanical indicator + LED, standard version.

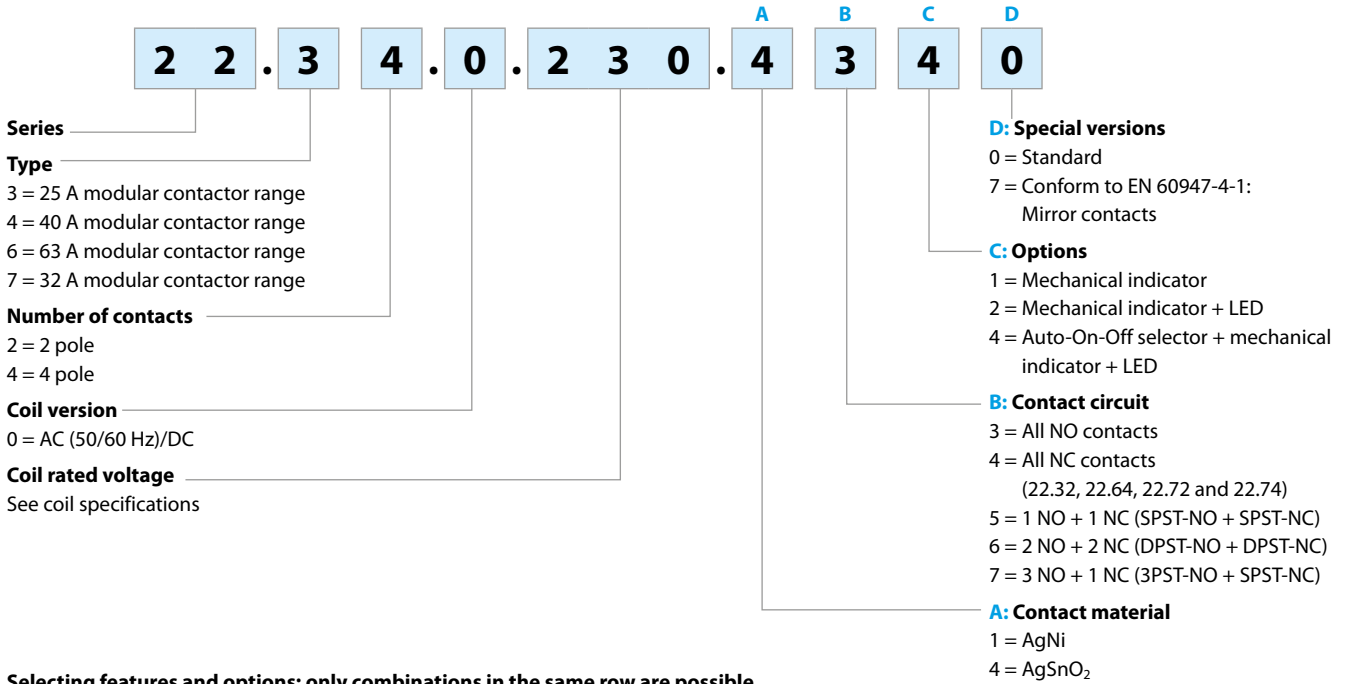

**Selecting features and options: only combinations in the same row are possible.**  
Preferred selections for best availability are shown in **bold**.

Type	Coil version	A	B	C	D
22.32	AC/DC	<b>1 - 4</b>	<b>3 - 4 - 5</b>	<b>2 - 4</b>	0
22.34	AC/DC	<b>1 - 4</b>	<b>3 - 6 - 7</b>	<b>2 - 4</b>	0
22.44	AC/DC	<b>4</b>	<b>3 - 6 - 7</b>	<b>1</b>	0 - 7
22.64	AC/DC	<b>4</b>	<b>3 - 4 - 6 - 7</b>	<b>1</b>	0 - 7
22.72	AC/DC	<b>1</b>	<b>3 - 4 - 5</b>	<b>1</b>	0 - 7
22.74	AC/DC	<b>1</b>	<b>3 - 4 - 6 - 7</b>	<b>1</b>	0 - 7



## Options

22.xx.x.xxx.xx4x – Auto-On-Off selector + mechanical indicator + LED (for Type 22.32 / 22.34)

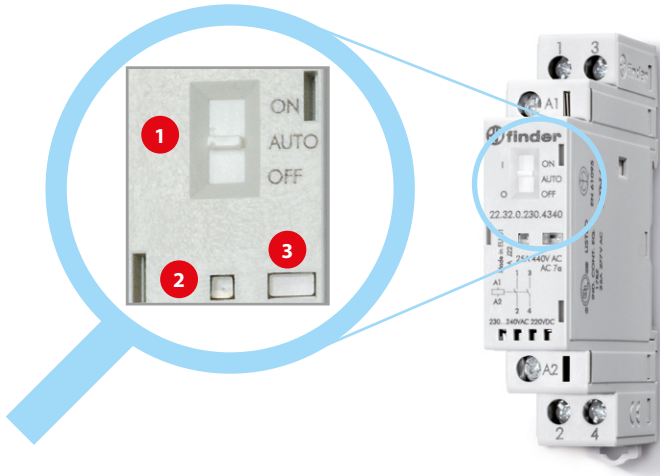

**1 Selector**

The three-position manual selector has the following functions:

- **ON position** - the contacts are latched in the operated state (NO contacts - closed and NC contacts - open), the mechanical indicator is visible in its window, the LED is not illuminated.
- **AUTO position** - the state of contacts, mechanical indicator and LED follow the coil supply voltage.
- **OFF position** - even if terminals A1 - A2 are supplied with rated voltage, the coil is not energized, and so the contacts remain in the non-operated state, the mechanical indicator is not visible and the LED is not illuminated.

**2 LED**

**3 Mechanical indicator**

22.xx.x.xxx.xx1x – Mechanical indicator (for Type 22.44 / 22.64 / 22.72 / 22.74)

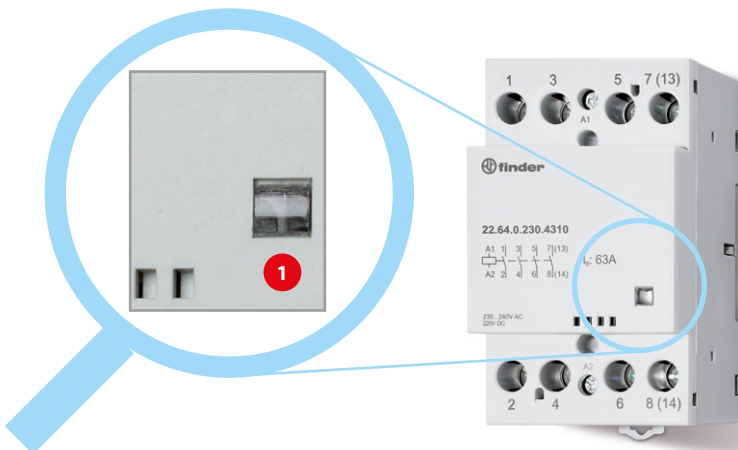

**1 Mechanical indicator**



## Technical data

Insulation		22.32/22.34		22.44/22.64	22.72/22.74		
Rated insulation voltage	V AC	250	440	440	440		
Pollution degree		3*	2	3	3		
<b>Insulation between coil and contact set</b>							
Type of insulation		Reinforced		Reinforced	Reinforced		
Overvoltage category		III		III	III		
Rated impulse voltage	kV (1.2/50 μs)	6		4	4		
Dielectric strength	V AC	4000		2000	2000		
<b>Insulation between adjacent contacts</b>							
Type of insulation		Basic		Basic	Basic		
Overvoltage category		III		III	III		
Rated impulse voltage	kV (1.2/50 μs)	4		4	4		
Dielectric strength	V AC	2500		2000	2000		
<b>Insulation between open contacts</b>		<b>NO contact</b>	<b>NC contact</b>	<b>NO/NC contacts</b>	<b>NO/NC contacts</b>		
Contact gap	mm	3	1.5	3	3		
Overvoltage category		III	II	III	III		
Rated impulse voltage	kV (1.2/50 μs)	4	2.5	4	4		
Dielectric strength	V AC/kV (1.2/50 μs)	2500/4	2000/3	2000/3	2000		
* Only for versions without Auto-On-Off selector. For versions with Auto-On-Off selector pollution degree 2 applies.							
<b>Insulation between coil terminals</b>							
Rated impulse voltage (surge) differential mode (according to EN 61000-4-5)	kV (1.2/50 μs)	4		2	2		
<b>Short circuit protection</b>		<b>22.32 / 22.34</b>	<b>22.44</b>	<b>22.64</b>	<b>22.72/22.74</b>		
Rated conditional short circuit current	kA	3	3	3	3		
Back-up fuse	A	32 (gL/gG type)	63	80	32		
<b>Terminals</b>		<b>Solid and stranded cable</b>					
		<b>22.32 / 22.34</b>	<b>22.44 / 22.64</b>	<b>22.72/22.74</b>			
Max. wire size – contact terminals	mm <sup>2</sup>	1 x 6 / 2 x 4	1 x 25 (solid) - 1 x 16 (stranded)	1 x 10 (solid) 1 x 6 (stranded)			
	AWG	1 x 10 / 2 x 12	1 x 4 (solid) - 1 x 6 (stranded)	1 x 7 (solid) 1 x 9 (stranded)			
Max. wire size – coil terminals	mm <sup>2</sup>	1 x 4 / 2 x 2.5	1 x 2.5	1 x 2.5			
	AWG	1 x 12 / 2 x 14	1 x 14	1 x 14			
Min. wire size – contact and coil terminals	mm <sup>2</sup>	1 x 0.2	1 x 1 (coil) - 1 x 1.5 (contacts)	1 x 1 (coil) - 1 x 1 (contacts)			
	AWG	1 x 24	1 x 18 (coil) - 1 x 16 (contacts)	1 x 17 (coil) - 1 x 1 (contacts)			
Screw torque	Nm	0.8	1.2 (coil terminals) - 3.5 (contact terminals)	0.6 (coil terminals) - 1.2 (contact terminal)			
Wire strip length	mm	9	10	7 (coil) - 9 (terminals)			
<b>Other data</b>		<b>22.32</b>	<b>22.34</b>	<b>22.44</b>	<b>22.64</b>	<b>22.72/22.74</b>	
Vibration resistance (10...150)Hz	g	4	4	3	3	3	
Shock resistance	g	10	10	15	15	15	
Power lost to the environment	without contact current	W	2	2	6	6	2.8
	with rated current	W	4.8	6.3	17	37	12.8

### Note

**22.32/22.34:** It is suggested an air gap of 9 mm between adjacent relays for installations and working conditions close to the limit (that is, ambient temperature > 40 °C, coil operated for a prolonged period of time, all contacts loaded with current > 20 A).

**22.44/22.64:** The maximum ambient temperature with 3 adjacent contactors is + 40 °C; when more than 3 contactors are installed, it is necessary an air gap of 9 mm. With 2 adjacent contactors the maximum ambient temperature is + 55 °C; when more than 2 contactors are installed, it is necessary an air gap of 9 mm.

## Current - Temperature derating

Type of contactor		22.72	22.74	22.44	22.64
Rated current	A	32	32	40	63
Operating ambient temperature	-25 °C...+55°C(I <sub>N</sub> )...+70 °C (2NO contacts)	-25 °C...+55°C(I <sub>N</sub> )...+70 °C (4 NO contacts)			
	-15 °C...+55 °C (1NO+1NC contacts)	-15 °C...+55°C(I <sub>N</sub> )...+70 °C (3 NO + 1 NC contacts)			
	-15 °C...+55 °C (2NC contacts)	-15 °C...+55 °C (2 NO + 2 NC contacts)			
	—	-15 °C...+55 °C (4 NC contacts)			
Max. thermal current up to +55 °C	A	32	32	40	63 (NO) - 50 (4 NC)
Max. thermal current @ +70 °C	A	25	25	40	50 (NO)
Number of contactors side-by-side:	≤40 °C	max. 3			
	(40...55) °C	max. 2			
	(55...70) °C	max. 1 (ventilation module or least 9 mm free space on each side)			
Min. conductor @ thermal current @ +70 °C	mm <sup>2</sup>	6	6	10	16
Tightening torque - main circuit	Nm	1.2	1.2	3.5	3.5

## Contact specification

### Ratings and utilization categories according to EN 61095: 2009

Type	Utilization category					
	AC-7a		AC-7b		AC-7c	
	Rated current (A)	Rated electrical life (Cycles)	Rated current (A)	Rated electrical life (Cycles)	Rated current (A)	Rated electrical life (Cycles)
22.32...1xx0 (AgNi contacts)	25	70 · 10 <sup>3</sup> (NO)	10	30 · 10 <sup>3</sup>	—	—
		30 · 10 <sup>3</sup> (NC)				
22.32...4xx0 (AgSnO <sub>2</sub> contacts)	25	30 · 10 <sup>3</sup>	10	30 · 10 <sup>3</sup>	10	30 · 10 <sup>3</sup>
22.34...1xx0 (AgNi contacts)	25	150 · 10 <sup>3</sup> (NO)	10	30 · 10 <sup>3</sup>	—	—
		100 · 10 <sup>3</sup> (NC)				
22.34...4xx0 (AgSnO <sub>2</sub> contacts)	25	30 · 10 <sup>3</sup>	10	30 · 10 <sup>3</sup>	10	30 · 10 <sup>3</sup>
22.44...4xx0	40	100 · 10 <sup>3</sup>	22	150 · 10 <sup>3</sup>	—	—
22.64...4xx0	63	100 · 10 <sup>3</sup>	30	150 · 10 <sup>3</sup>	—	—
22.72...1410	32	150 · 10 <sup>3</sup> (NO) - 100 · 10 <sup>3</sup> (NC)	9 (NO) / 6 (NC)	30 · 10 <sup>4</sup>	—	—
22.74...1410	32	150 · 10 <sup>3</sup>	8.5	50 · 10 <sup>4</sup>	—	—

Utilization category: **AC-7a** = Slightly inductive loads ( $\cos\phi = 0.8$ )

**AC-7b** = Motor loads; ( $\cos\phi = 0.45$ ,  $I_{making} = 6x I_{breaking}$ )

**AC-7c** = Compensated electric discharge lamps ( $\cos\phi = 0.9$ ,  $C = 10 \text{ mF/A}$ )

#### H 22 - Maximum DC1 breaking capacity - Type 22.32/22.34

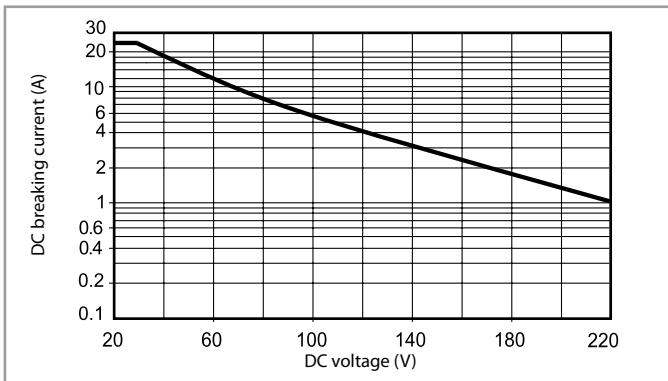

#### H 22 - Maximum DC1 breaking capacity - Type 22.44/22.64

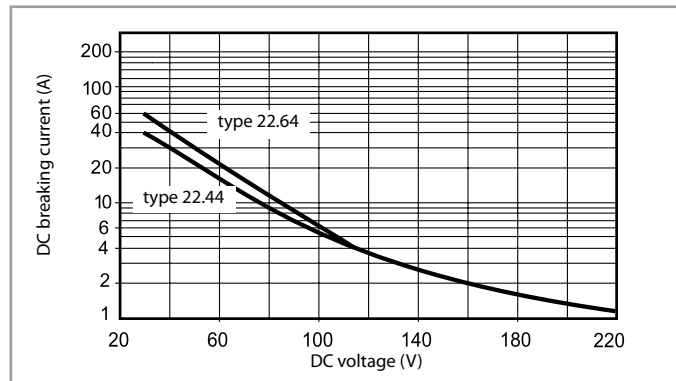

- When switching a resistive load (DC1) having voltage and current values under the curve, an electrical life of  $\geq 100 \cdot 10^3$  can be expected.
- In the case of DC13 loads, the connection of a diode in parallel with the load will permit a similar electrical life as for a DC1 load.  
Note: the release time for the load will be increased.

#### H 22 - Maximum DC1 breaking capacity - Type 22.72/22.74

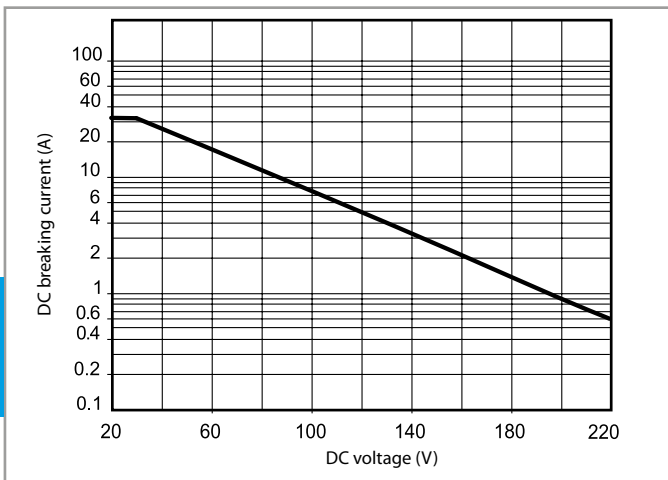

### Coil specifications

AC/DC version data (type 22.32)

Nominal voltage $U_N$ V	Coil code	Operating range		Rated coil consumption $I_N$ at $U_N$ (AC) mA
		$U_{min}$ V	$U_{max}$ V	
12	0.012	9.6	13.2	165
24	0.024	19.2	26.4	83
48	0.048	38.4	52.8	42
60	0.060	48	66	33
120 (110...125)	0.120	88	138	16.5
230 (230...240 AC) (220 DC)	0.230	184 (AC) 176 (DC)	264 (AC) 242 (DC)	8.7

AC/DC version data (type 22.34)

Nominal voltage $U_N$ V	Coil code	Operating range		Rated coil consumption $I_N$ at $U_N$ (AC) mA
		$U_{min}$ V	$U_{max}$ V	
12	0.012	9.6	13.2	165
24	0.024	19.2	26.4	83
48	0.048	38.4	52.8	42
60	0.060	48	66	33
120 (110...125)	0.120	88	138	16.5
230 (230...240 AC) (220 DC)	0.230	184 (AC) 176 (DC)	264 (AC) 242 (DC)	8.7

AC/DC version data (type 22.44 / 22.64)

Nominal voltage $U_N$ V	Coil code	Operating range		Rated coil consumption $I_N$ at $U_N$ (AC) mA
		$U_{min}$ V	$U_{max}$ V	
12	0.012	10.2	13.2	495
24	0.024	20.4	26.4	250
120 (110...125)	0.120	102	138	50
230 (230...240 AC) (220 DC)	0.230	196	264 (AC) 242 (DC)	26

AC/DC version data (type 22.72)

Nominal voltage $U_N$ V	Coil code	Operating range		Rated coil consumption $I_N$ at $U_N$ (AC) mA
		$U_{min}$ V	$U_{max}$ V	
24	0.024	20.4	26.4	98
48	0.048	40.8	52.8	44
110	0.110	93.5	121	20
230	0.230	195.5	253	9.2

AC/DC version data (type 22.74)

Nominal voltage $U_N$ V	Coil code	Operating range		Rated coil consumption $I_N$ at $U_N$ (AC) mA
		$U_{min}$ V	$U_{max}$ V	
24	0.024	20.4	26.4	110
48	0.048	40.8	52.8	54.6
110	0.110	93.5	121	24.5
230	0.230	195.5	253	10.8

R 22 - Coil operating range v ambient temperature

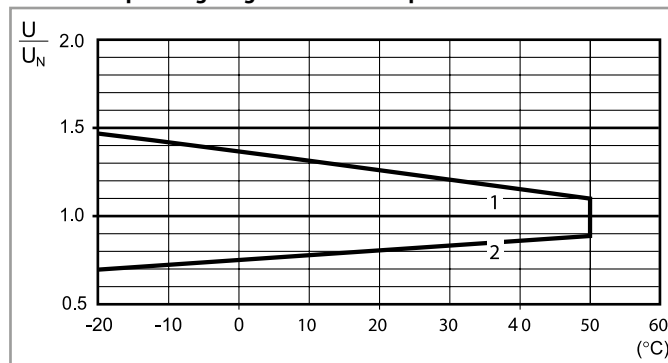

- 1 - Max. permitted coil voltage.
- 2 - Min. pick-up voltage with coil at ambient temperature.

Wiring diagrams

Type 22.32

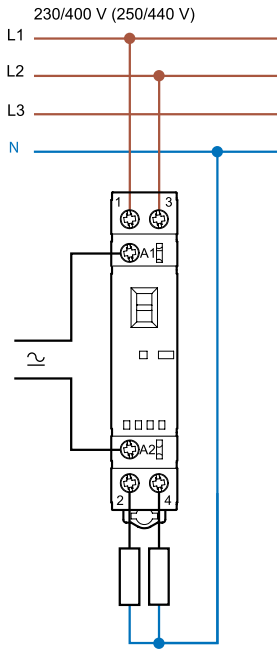

Type 22.34

Line and neutral switched

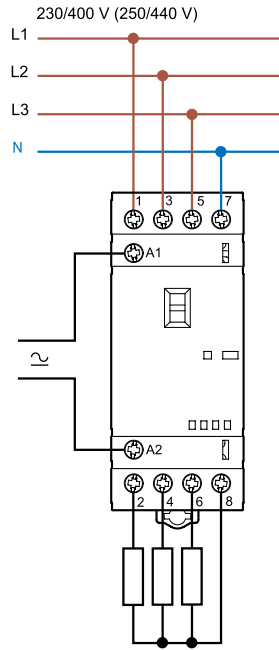

Type 22.34

Line only switched

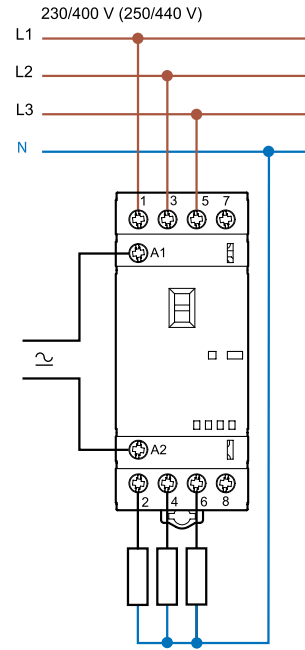

Type 22.44/22.64

Line and neutral switched

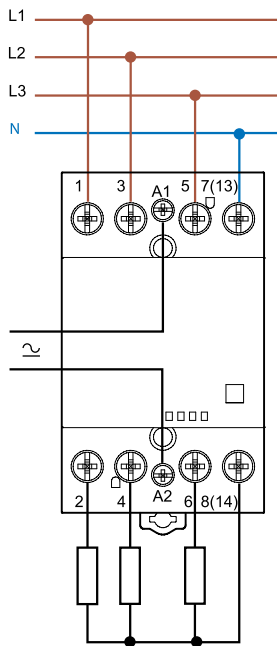

Type 22.44/22.64

Line only switched

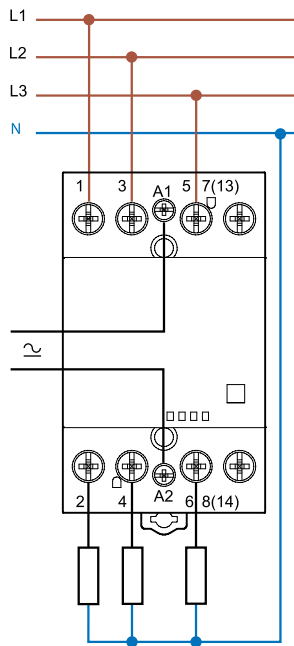

Type 22.xx.4717

Mirror Contacts

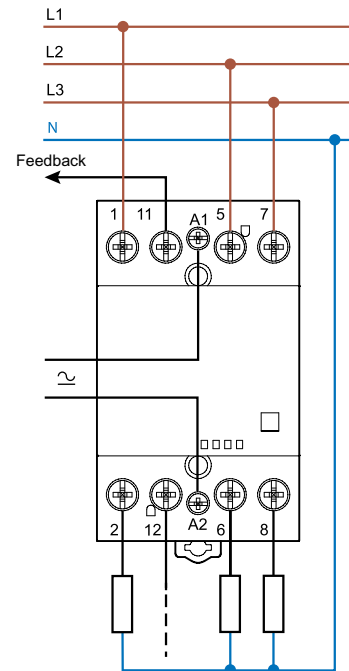

Example of application of contactor with Mirror Contacts: Normally closed contact is definitely in open position if the normally open contact is closed

Wiring diagrams

Type 22.72

Phase interruption only

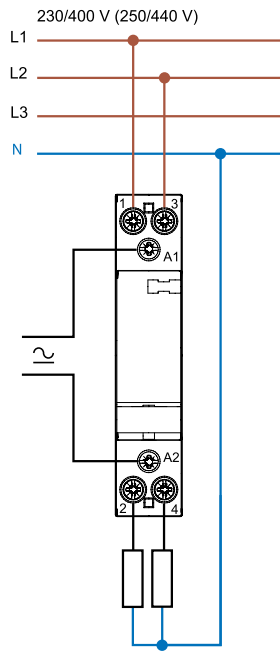

Type 22.74

Phase and neutral interruption

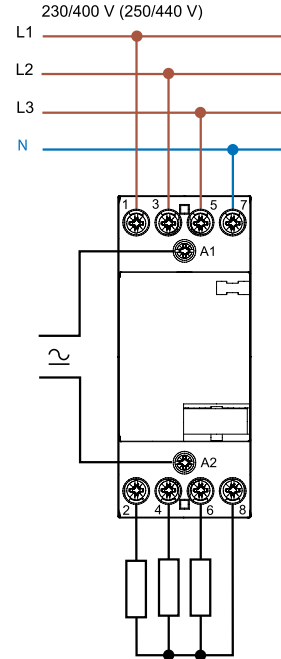

Outline drawings

Type 22.32  
Box clamp

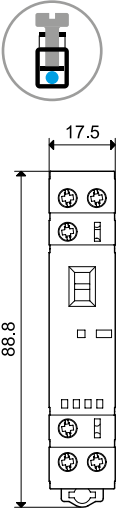

Type 22.32 + 022.33/022.35  
Box clamp

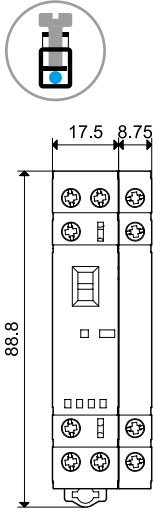

Type 22.34  
Box clamp

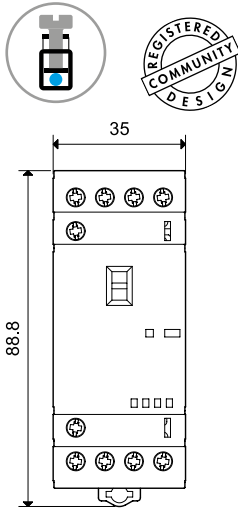

Type 22.34 + 022.33/022.35  
Box clamp

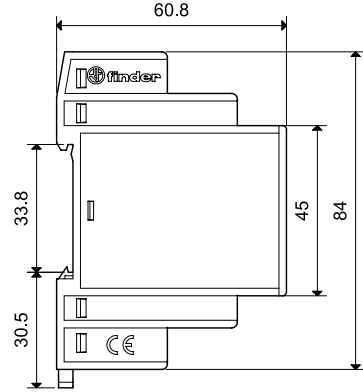
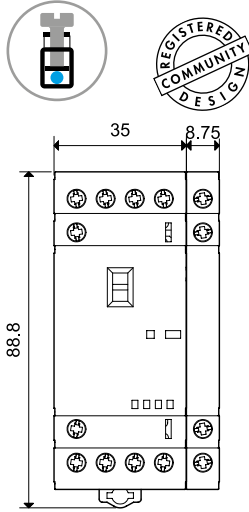

Types 22.44/22.64  
Box clamp

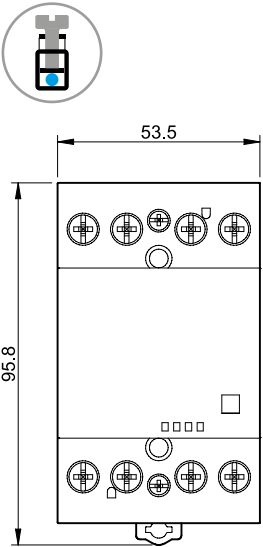

Types 22.44/22.64 + 022.63/022.65  
Box clamp

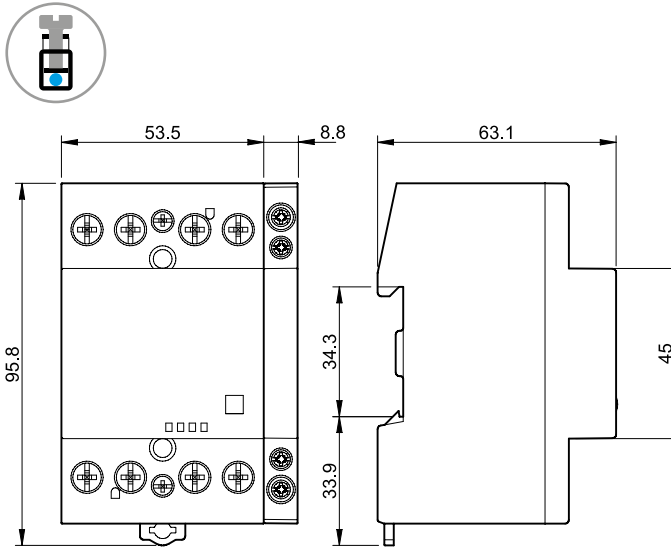

Type 22.72  
Box clamp

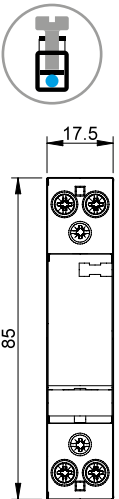

Types 22.74  
Box clamp

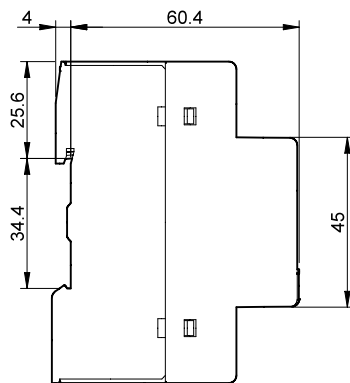
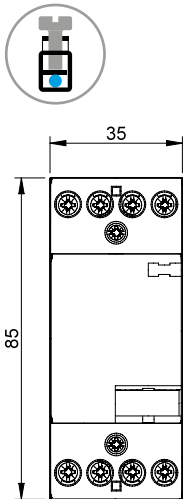

Outline drawings

Types 022.33/022.35  
Box clamp

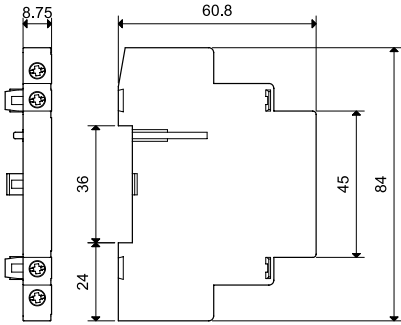

Types 022.63/022.65  
Box clamp

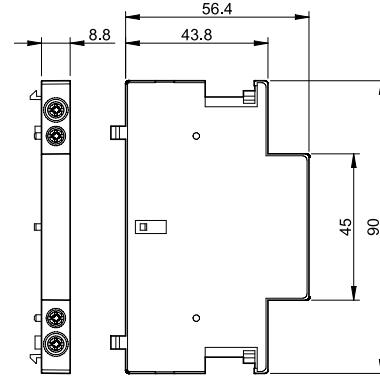

Types 022.73/022.75  
Box clamp

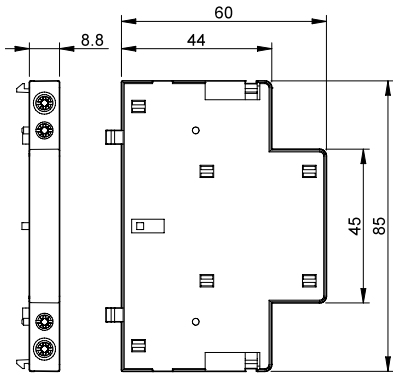

**Auxiliary modules**

Mechanically linked contacts according to Annex L of EN 60947-5-1

	022.33	022.35	022.63	022.65	022.7x
Type of contactor	Type 22.32 Type 22.34		Type 22.44 Type 22.64		Type 22.74
<b>Contact specification</b>					
Contact configuration	2 NO	1 NO + 1 NC	2 NO	1 NO + 1 NC	2 NO   1 NO + 1 NC
Conventional free air thermal current I <sub>th</sub> A	6		6		6
Rated power AC15 (230 V) VA	700		700		700
Electrical life at rated load cycles	30 · 10 <sup>3</sup>		30 · 10 <sup>3</sup>		30 · 10 <sup>3</sup>
Minimum switching load mW (V/mA)	1000 (10/10)		1000 (10/10)		1000 (10/10)
Contact material	AgNi		AgNi		AgNi
<b>Short circuit protection</b>					
Rated conditional short circuit current kA	1		1		1
Back-up fuse A	6 (gL/gG type)		6 (gL/gG type)		6 (gL/gG type)
<b>Terminals</b>	<b>Solid and stranded cable</b>		<b>Solid and stranded cable</b>		<b>Solid and stranded cable</b>
Max. wire size mm <sup>2</sup>	1 x 4 / 2 x 2.5		1 x 2.5		1 x 2.5
AWG	1 x 12 / 2 x 14		1 x 14		1 x 14
Min. wire size mm <sup>2</sup>	1 x 0.2		1 x 1		1 x 1
AWG	1 x 24		1 x 18		1 x 18
⊕ Screw torque Nm	0.6		0.6		0.6
Wire strip length mm	9		9		9
<b>Power lost to the environment</b>					
without contact current W	—		—		—
with rated current W	0.5		0.5		0.5
<b>Approvals</b> (according to type)					

NOTE: It is not possible to assembly the auxiliary module on 22.32.0.xxx.x4x0 (2 NC versions).



22.32 + 022.33/022.35



22.44 + 022.63/022.65



22.34 + 022.33/022.35



22.64 + 022.63/022.65



Accessories



020.01

Adaptor for panel mounting (for 22.32 type), plastic, 17.5 mm wide

020.01

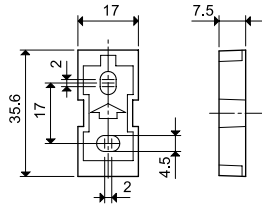

011.01

Adaptor for panel mounting (for 22.34 type), plastic, 35 mm wide

011.01

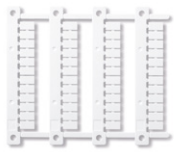
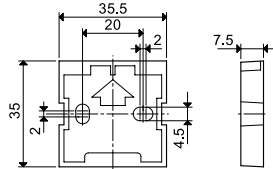

060.48

Sheet of marker tags (CEMBRE Thermal transfer printers) for all relays (48 tags), 6 x 12 mm

060.48



019.01

Identification tag, plastic, 1 tag, 17x25.5 mm

019.01



022.09

Separator for rail mounting, plastic, 9 mm wide

022.09

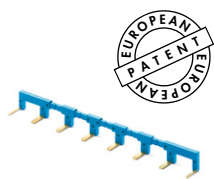
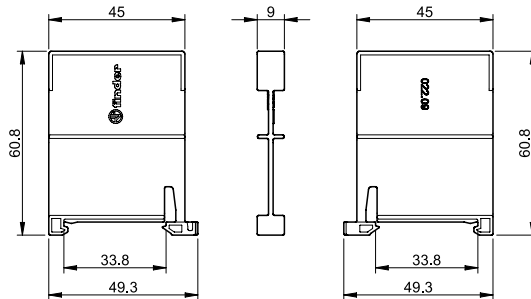

022.18



8-way jumper link for type 22.32, 17.5 mm wide

022.18 (blue)

Rated values

10 A - 250 V

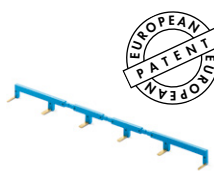
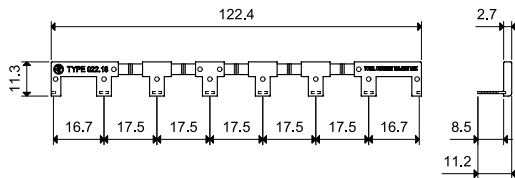

022.26



6-way jumper link for type 22.34, 35 mm wide

022.26 (blue)

Rated values

10 A - 250 V

