

# Relé de impulso modular 16 A



Persianas automatizadas



Corredores: controle de iluminação (hotel, hospital, etc.)



Controle de iluminação de quartos



Controle de iluminação de sala de estar



SÉRIE  
20



**1 ou 2 contatos 16 A - Relé de impulso modular para montagem direta em trilho 35 mm (EN 60715)**

- 17,4 mm de largura
- Botão de teste e indicador mecânico
- 7 sequências disponíveis
- Bobina AC ou DC
- Placa de identificação
- De acordo com EN 60601-1 2 x MOPP
- Pode ser usado com botões luminosos através do adaptador 026.00
- Montagem em trilho 35 mm (EN 60715)
- Contatos sem Cádmi

20.21/20.2x/20.23  
Conexão a parafuso



PARA CARGA DE MOTOR E CARGA PILOT DUTY HOMOLOGADAS PELA UL, VEJA:  
"Informações técnicas gerais" na página IX

Para as dimensões do produto vide a página 5

**Características dos contatos**

Configurações dos contatos	1 NA	2 NA	1 NA + 1 NF
Corrente nominal/Máx corrente instantânea A	16/30	16/30	16/30
Tensão nominal/Máx tensão comutável V AC	250/400	250/400	250/400
Carga nominal em AC1 VA	4000	4000	4000
Carga nominal em AC15 (230 V AC) VA	750	750	750
Carga máx. da lâmpada:			
230 V incandescente/halógena W	2000	2000	2000
fluorescente com reator eletrônico W	1000	1000	1000
fluorescente com reator eletromagnético W	750	750	750
CFL W	400	400	400
LED 230 V W	400	400	400
halógena ou LED com transformador eletrônico W	400	400	400
halógena ou LED com transformador eletromagnético W	800	800	800
Carga mínima comutável mW (V/mA)	1000 (10/10)	1000 (10/10)	1000 (10/10)
Material dos contatos standard	AgSnO <sub>2</sub>	AgSnO <sub>2</sub>	AgSnO <sub>2</sub>

**Características da bobina**

Tensão nominal (UN)	V AC (50/60 Hz)	8 - 12 - 24 - 48 - 110 - 120 - 230 - 240		
	V DC	12 - 24 - 48 - 110	12 - 24 - 48 - 110	12 - 24 - 48 - 110
Potência nominal AC/DC VA (50 Hz)/W		6.5/5	6.5/5	6.5/5
Campo de funcionamento	AC	(0.85...1.1)U <sub>N</sub> (50 Hz)/(0.9...1.1)U <sub>N</sub> (60 Hz)		
	DC	(0.9...1.1)U <sub>N</sub>	(0.9...1.1)U <sub>N</sub>	(0.9...1.1)U <sub>N</sub>

**Características gerais**

Vida mecânica AC/DC	ciclos	300 · 10 <sup>3</sup>	300 · 10 <sup>3</sup>	300 · 10 <sup>3</sup>
Vida elétrica a carga nominal em AC1	ciclos	100 · 10 <sup>3</sup>	100 · 10 <sup>3</sup>	100 · 10 <sup>3</sup>
Mín./Máx. duração do impulso		0.1 s/1 h (segundo EN 60669)	0.1 s/1 h (segundo EN 60669)	0.1 s/1 h (segundo EN 60669)
Isolamento entre a bobina e os contatos (1.2/50 μs)	kV	4	4	4
Temperatura ambiente	°C	-40...+40	-40...+40	-40...+40
Grau de proteção		IP 20	IP 20	IP 20

**Homologações** (segundo o tipo)



## Codificação

Exemplo: Série 20, montagem em trilho 35 mm (EN 60715), interruptor bipolar, 2 NA - 16 A, alimentação 12 V DC, com contatos AgSnO<sub>2</sub>.

2 0 . 2 2 . 9 . 0 1 2 . 4 0 0 0

Série

Tipo

2 = Montagem em trilho 35 mm (EN 60715)

Número de contatos

- 1 = Interruptor unipolar 1 NA
- 2 = Interruptor bipolar 2 NA
- 3 = Inversor 1 NA + 1 NF
- 4 = Comutador 4 sequências 2 NA
- 6 = Comutador 3 sequências 2 NA
- 7 = Comutador 3 sequências 2 NA
- 8 = Comutador 4 sequências 2 NA

Material dos contatos

- 0 = AgNi
- 4 = AgSnO<sub>2</sub>

Tensão nominal bobina

Vide características da bobina

Versão da bobina

- 8 = AC (50/60 Hz)
- 9 = DC

## Características gerais

### Isolamento

Rigidez dielétrica		
entre alimentação e contatos	V AC	4000
entre contatos abertos	V AC	2000
entre contatos adjacentes	V AC	2000

### Outros dados

Potência dissipada no ambiente com carga nominal e bobina desexcitada	W	1.3 (20.21, 20.23, 20.28)	2.6 (20.22, 20.24, 20.26, 20.27)		
 Torque	Nm	0.8	0.8		
Terminais guiados seção disponível	<b>Terminal bobina</b>		<b>Terminal contato</b>		
		fio rígido	fio flexível	fio rígido	fio flexível
	mm <sup>2</sup>	1 x 4 / 2 x 2.5	1 x 2.5 / 2 x 2.5	1 x 6 / 2 x 4	1 x 4 / 2 x 2.5
	AWG	1 x 12 / 2 x 14	1 x 14 / 2 x 14	1 x 10 / 2 x 12	1 x 12 / 2 x 14

No caso da bobina permanecer alimentada durante longo tempo, é necessário garantir uma ventilação adequada para o relé. Por exemplo, deixando um espaço vazio de aproximadamente 9 mm entre pares de relés.





















## Características da bobina

### Dados da versão DC

Tensão nominal	Código bobina	Campo de funcionamento		Resistência	Corrente nominal I <sub>a</sub> U <sub>N</sub>
		U <sub>min</sub>	U <sub>max</sub>		
U <sub>N</sub>		V	V	Ω	mA
12	9.012	10.8	13.2	27	440
24	9.024	21.6	26.4	105	230
48	9.048	43.2	52.8	440	110
110	9.110	99	121	2330	47

### Dados da versão AC

Tensão nominal	Código bobina	Campo de funcionamento		Resistência	Corrente nominal I <sub>a</sub> U <sub>N</sub> (50 Hz)
		U <sub>min</sub>	U <sub>max</sub>		
U <sub>N</sub>		V	V	Ω	mA
8	8.008	6.8	8.8	4	800
12	8.012	10.2	13.2	7.5	550
24	8.024	20.4	26.4	27	275
48	8.048	40.8	52.8	106	150
110	8.110	93.5	121	590	64
120	8.120	102	132	680	54
230	8.230	192	253	2500	28
240	8.240	204	264	2700	27.5

Tipo	Número de impulsos	Sequências			
		1	2	3	4
20.21	2				
20.22	2				
20.23	2				
20.24	4				
20.26	3				
20.27	3				
20.28	4				

## Esquemas de ligação

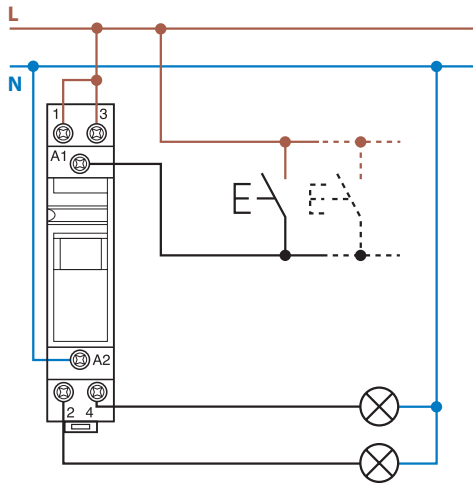

Exemplo: tensão de alimentação 230 V AC.

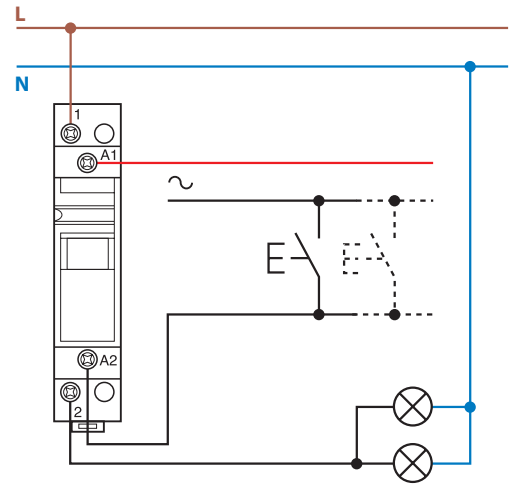

Exemplo: tensão de alimentação 24 V AC.

## Dimensões do produto

Tipo 20.21

Conexão a parafuso

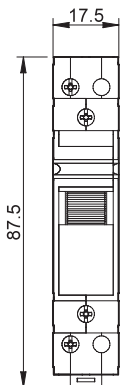

Tipo 20.22/24/26/27/28

Conexão a parafuso



Tipo 20.23

Conexão a parafuso

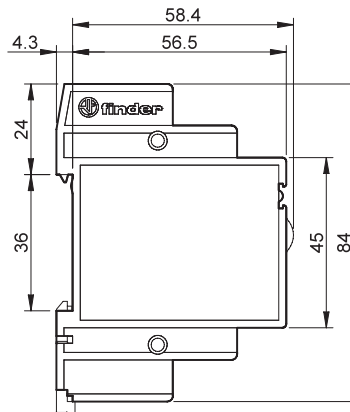

## Acessórios

## Módulo para pulsadores luminosos

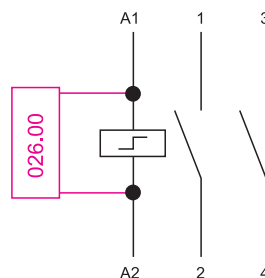
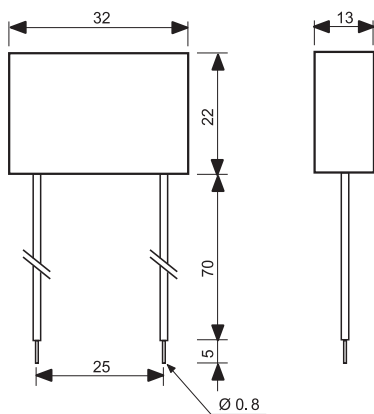
**Tipo 026.00**

Versão hermética com prensa-cabo isolado e flexível de 7.5 cm.

**Exemplo de esquema de ligação do tipo 026.00**

Em caso de aplicação do relé Série 20 com botões luminosos, é necessária a montagem em paralelo de módulo capacitor à bobina do relé (máximo até 15 botões luminosos 1 mA 230 V).



020.01

**Suporte para fixação em painel, 17.5 mm de largura**

020.01



022.09

**Separador para montagem em trilho, plástico, largura 9 mm**

022.09

