







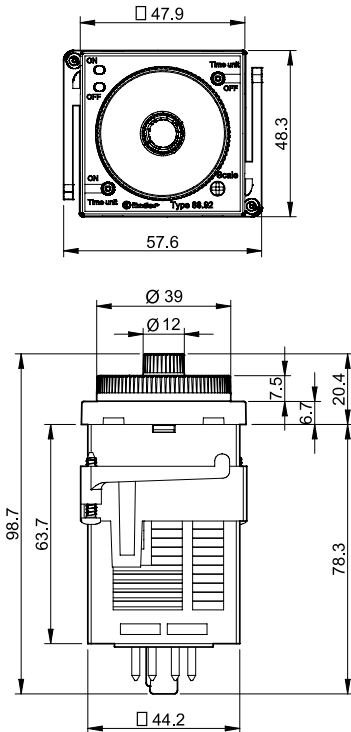
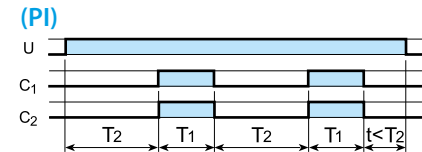
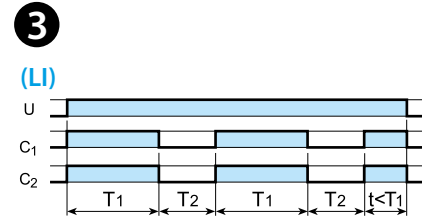
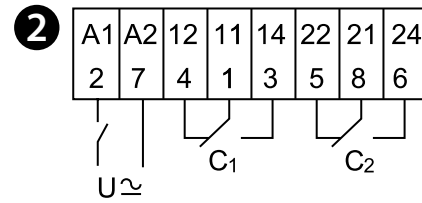
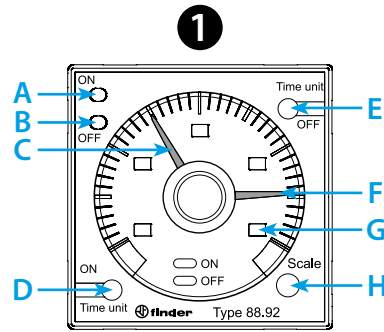

88.92

Utility Model - IB8892001 - 11/24 - Finder S.p.A. con unico socio - 10040 ALMESE (TO) - ITALY

	88.92.0.240.000X U _N (12...240)V AC (50/60 Hz) / DC U _{min} 10.8 V AC / DC U _{max} 264.5 V AC / DC P 2.5 VA (230 V) / 1.5 W (24 V)
	2 CO (DPDT) 8 A 250 V AC AC1 2000 VA AC15 (230 V AC) 400 VA (M) (230 V AC) 0.3 kW DC1(24/110/220)V (8/0.3/0.12)A
	(-10...+55)°C
IP40	



LED A (ON)	LED B (OFF)	U _N		
-	-	-	11 - 14 21 - 24	11 - 12 21 - 22
	-	✓	11 - 12 21 - 22	11 - 14 21 - 24
-		✓	11 - 14 21 - 24	11 - 12 21 - 22

H	D - E					
	s	10 s	min	10 min	h	10 h
1.2	1.2 s	12 s	1.2 min	12 min	1.2 h	12 h
3	3 s	30 s	3 min	30 min	3 h	30 h
12	12 s	120 s	12 min	120 min	12 h	120 h
30	30 s	300 s	30 min	300 min	30 h	300 h

DEUTSCH

88.92

ZEITRELAIS, ASYMMETRISCHER BLINKGEBER,
FÜR FRONTTAFELINBAU ODER FASSUNGEN

1 FRONTANSICHT

- A EIN-Anzeige (T1): Rote LED leuchtet
- B AUS-Anzeige (T2): Grüne LED leuchtet
- C Einstellring mit rotem Zeiger: Impulszeit -Einstellung T1
- D Zeitbereichs-Schalter EIN (T1): (s-10s - m-10min - h-10h) (*)
- E Zeitbereichs-Schalter AUS (T2): (s-10s - m-10min - h-10h) (*)
- F Einstellung mit grünem Zeiger: Pausenzeit -Einstellung T2
- G Gewählte Zeitskala
- H Zeitskalenfaktor-Schalter

2 ANSCHLUSSBILD

3 FUNKTIONEN

- LI Asymmetrischer Blinkgeber (impulsbeginnend) (88.92.0.240.0001)
- PI Asymmetrischer Blinkgeber (pausebeginnend) (88.92.0.240.0000)

HINWEIS

- Die Zeit (D-E-H) muss vor dem Anlegen der Betriebsspannung gewählt werden
- Zeitbereich: (25 ms...300 h)
- Wiederbereitsschaftsdauer: 200 ms
- Einstellgenauigkeit: ± 1%
- (*) s (Sekunden), s10 (Sekunden x10), m (Minuten), m10 (Minuten x10), h (Stunden), h10 (Stunden x10)