











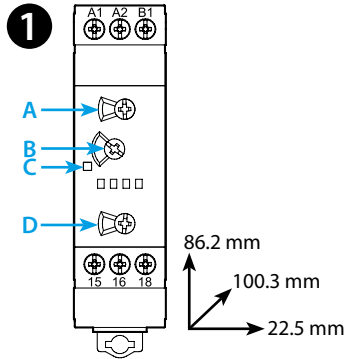

83.01

83.01.0.240.0000	
	U_N (24...240)V AC (50/60 Hz) / DC U_{min} 16.8 V AC / DC U_{max} 265 V AC / DC $P < 1.5 VA / < 2 W$
	1 CO (SPDT) 16 A 250 V AC AC1 4000 VA AC15 (230 V AC) 750 VA (M) (230 V AC) 0.5 kW DC1 (24/110/220)V (16/0.3/0.12)A
	(-20...+60)°C
IP20	



LED	U_N		
	-	15 - 18	15 - 16
	✓	15 - 18	15 - 16
	✓		15 - 16
	✓	15 - 16	15 - 18

Utility Model - IB8301001 - 11/24
 Finder S.p.A. con unico socio - 10040 ALMESE (TO) - ITALY

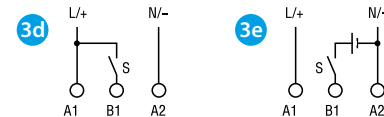
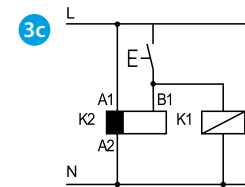
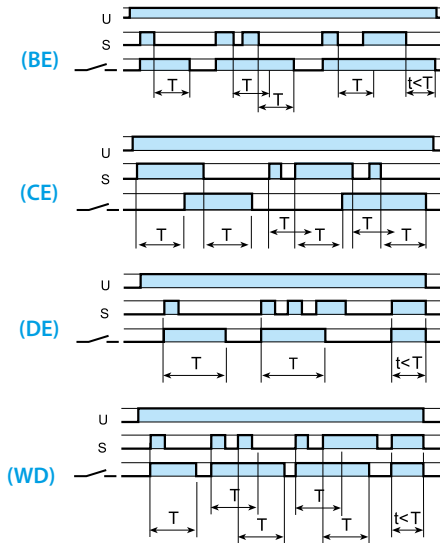
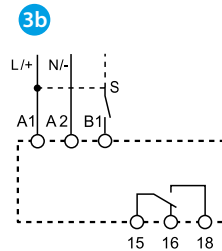
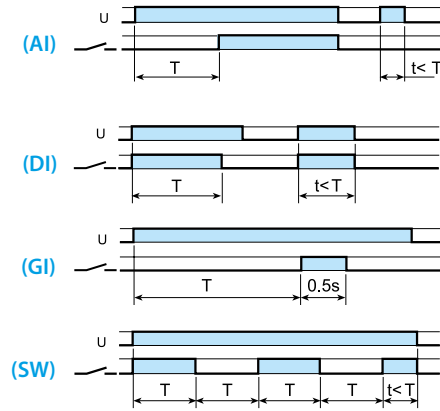
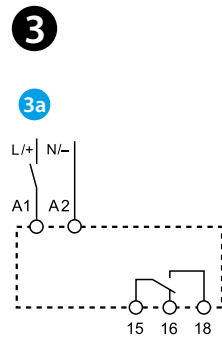
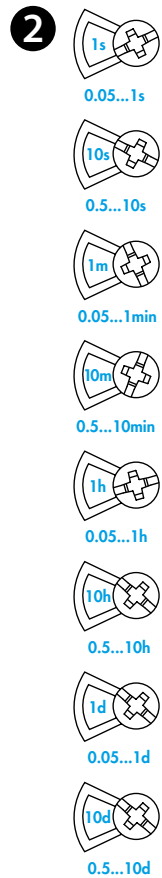

ENGLISH

83.01 MODULAR TIMER

1 FRONT VIEW

- A Time scales rotary selector
- B Time setting
- C LED
- D Functions rotary selector

2 TIME SCALES

3 WIRING DIAGRAM AND FUNCTIONS

(WARNING: the functions must be set before energising the timer)

3a Without signal START functions

Start via contact in supply line (A1)

- AI On-delay
- DI Interval
- GI Pulse delayed
- SW Symmetrical flasher (starting pulse on)

3b External START functions

Start via contact into control terminal (B1)

- BE Off-delay with control signal
- CE On- and off-delay with control signal
- DE Interval with control signal on
- WD Watchdog (Retriggerable interval with control signal on)

3c Possible to control an external load, such as another relay coil or timer, connected to the signal start terminal B1

3d With DC supply, positive polarity has to be connected to B1 terminal (according to EN 60204-1)

3e A voltage other than the supply voltage can be applied to the command Start (B1), example: A1-A2 = 230 V AC
 B1-A2 = 24 V DC

OTHER DATA

- Minimum control impulse: 50 ms
- Recovery time: 200 ms
- 35 mm rail mount (EN 60715)

WORKING CONDITIONS

In conformity with the European Directive on EMC 2014/30/EU, the timer relay has a level of immunity, against radiated and conducted disturbances, considerably higher than requirements of EN 61812-1 standard. However, devices like transformers, motors, contactors, switches and power cables may cause disturbances and even damage the timer electronic circuit. For that reason, the wiring cables must be as short as possible, and, when necessary, the timer shall be protected by the relevant RC network, varistor or surge voltage protector.