





**7T.81**



	<b>7T.81.0.000.240x</b>	<b>7T.81.0.000.230x</b>
	1 NC (SPST-NC) 10 A 250 V AC	1 NO (SPST-NO) 10 A 250 V AC
	AC1 2500 VA AC15 (230 V AC) 250 VA AC3 (230 V AC) 1.1 kW DC1 (24/110/220)V (1/0.3/0.15)A	
<b>K</b>	7 ± 4	
	(-45...+80)°C	
	IP20	



⊕ 0.5 Nm



(1x2.5) mm<sup>2</sup>  
(1x12) AWG



(1x1.5) mm<sup>2</sup>  
(1x16) AWG

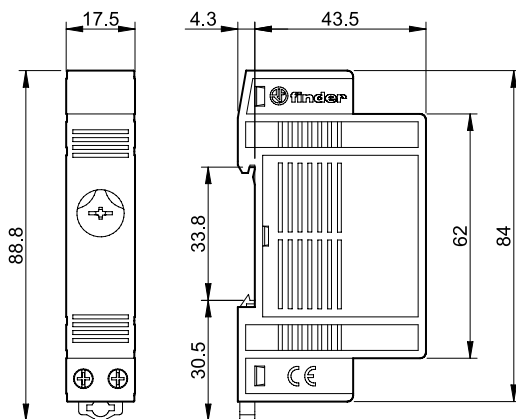

Type of action: 1B  
Pollution degree: 2  
Rated impulse voltage 2.500 V

**7T.81.0.000.2401** (-20...+40)°C  
**7T.81.0.000.2402** (-20...+60)  
**7T.81.0.000.2403** (0...+60)°C

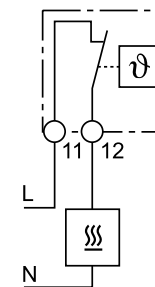
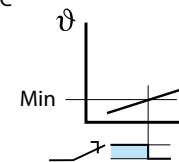
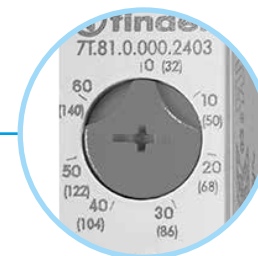
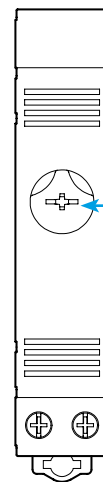

**7T.81.0.000.2301** (-20...+40)°C  
**7T.81.0.000.2302** (-20...+60)  
**7T.81.0.000.2303** (0...+60)°C

