











10.41

EN 60669-1 / EN 60669-2-1				
	10.41.8.120.0000 U _N 120 V AC (50/60 Hz) U _{min} 96 V AC U _{max} 132 V AC P 2 VA		10.41.8.230.0000 U _N 230 V AC (50/60 Hz) U _{min} 184 V AC U _{max} 253 V AC P 2 VA	
	1 NO (SPST-NO) 16 A 120 V AC μ		1 NO (SPST-NO) 16 A 230 V AC μ	
	AC1	1900 VA	AC1	3700 VA
	AC15	400 VA	AC15	750 VA
	(120 V AC)		(230 V AC)	2000 W
	(120 V AC)	400 W	(230 V AC)	750 W
	CFL	200 W	CFL - LED	400 W
	IP54			

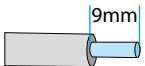
	(-30...+70)°C
TON = 15s	
TOFF = 30s	

		
0.8 Nm	(1x6/2x4) mm ² (1x10/2x12) AWG	(1x6/2x2.5) mm ² (1x10/2x14) AWG

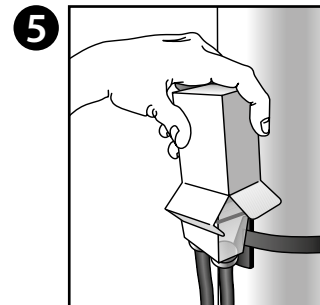
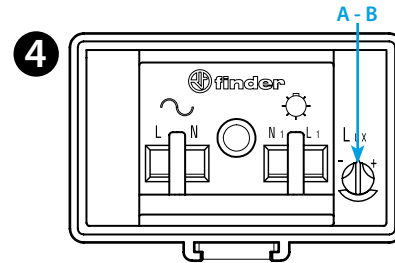
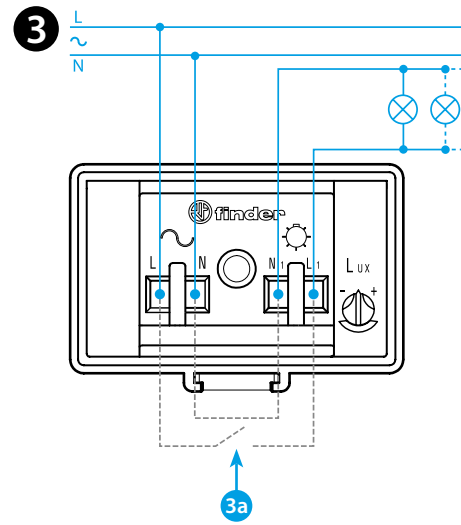
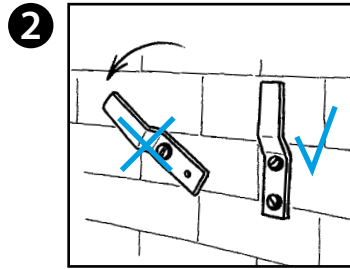
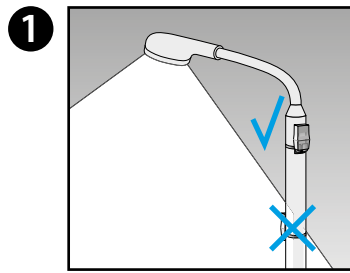
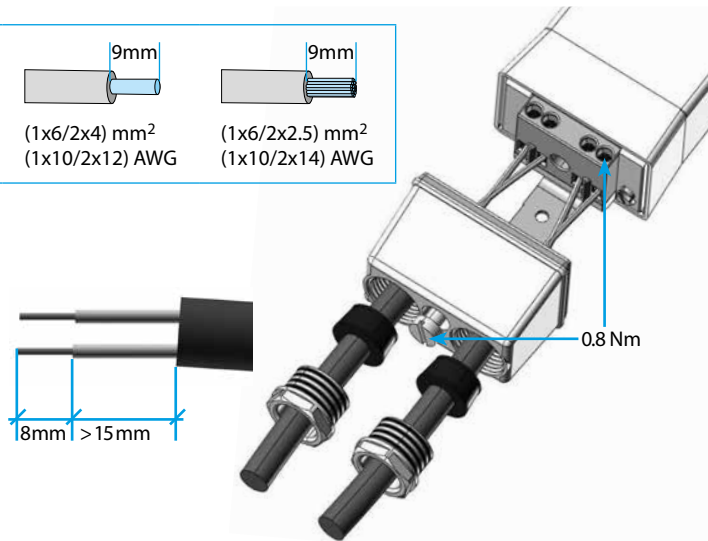

ENGLISH

10.41 LIGHT DEPENDENT RELAY

It is recommended to install the relay such that the light emitted from the controlled lamp(s) does not influence the sensor. Where this is not possible, the innovative "light feedback compensation" principle will avoid annoying lamp switch-on and switch-off, provided that the sum of ambient light and controlled light does not exceed 120 lux. Ensure that the cable compression gland is tightened to achieve IP54 sealing.

1 POLE MOUNTING

2 WALL MOUNTING

3 WIRING DIAGRAM

Only the live of the load circuit is interrupted, between terminals L and L1. Terminals N and N1 have been provided to aid installation, but they are internally linked.

Make the electrical connections according to the diagram, ensuring that the cable gland is tightened around the cable.

Cable type suggested: H07RN-F (2x1 mm²...2x2,5 mm²) or similar.

Important Safety Advice: if the lamp has a ground wire terminal, it is necessary to connect it to the protective earth system before activation.

3a Internal connections

4 SETTINGS

A ambient light threshold (1...80)lx

B LED (behind the transparent adjustment knob):

- slow blinking: supply ON, relay OFF
- fast blinking: supply ON, timing in progress, relay OFF
- continuous: supply ON, relay ON

5 TESTING

Over the first 3 working cycles the On and Off delay times are reduced to zero in order to aid installation.

The packaging can be used to darken the photocell in order to test or regulate the relay.