

Subminiature PCB relays 6 A



Copiers



Hi-Fi systems



Washing
machines



Control
systems



Electronic kits



Medical and
dentistry

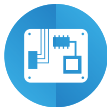

Electronic circuit
boards



Programmable
controllers

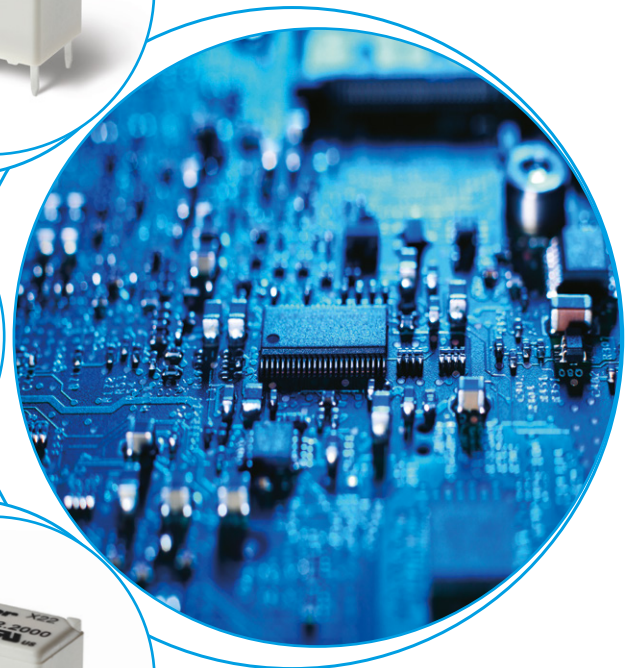
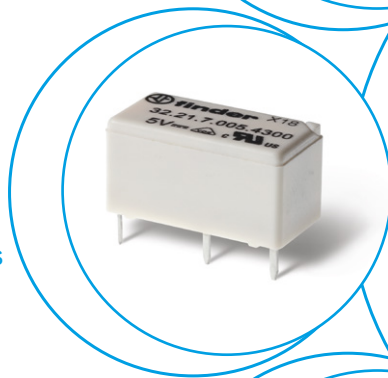

Printed circuit mount 6 A relay

- 1 Pole changeover contacts or 1 Pole normally open contact
- Subminiature, low profile package
- Sensitive DC coil - 200 mW
- Wash tight: RT III
- Cadmium Free contacts

32.21-4000



- 1 CO (SPDT), 6 A
- Low coil power
- PCB mount

32.21-4300



- 1 NO (SPST-NO), 6 A
- Low coil power
- PCB mount

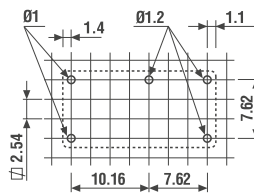
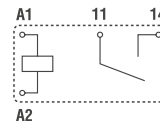
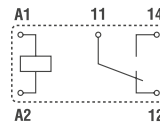

Copper side view

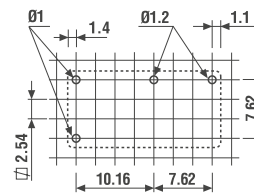

Copper side view

For outline drawing see page 5

Contact specification

Contact configuration		1 CO (SPDT)	1 NO (SPST-NO)
Rated current/Maximum peak current	A	6/15	6/15
Rated voltage/ Maximum switching voltage	V AC	250/400	250/400
Rated load AC1	VA	1500	1500
Rated load AC15 (230 V AC)	VA	250	250
Single phase motor rating (230 V AC)	kW	0.185	0.185
Breaking capacity DC1: 30/110/220 V	A	3/0.35/0.2	3/0.35/0.2
Minimum switching load	mW (V/mA)	500 (10/5)	500 (10/5)
Standard contact material		AgSnO ₂	AgSnO ₂

Coil specification

Nominal voltage (U _N)	V AC (50/60 Hz)	—	—
	V DC	5 - 12 - 24 - 48	5 - 12 - 24 - 48
Rated power AC/DC	VA (50 Hz)/W	—/0.2	—/0.2
Operating range	AC	—	—
	DC	(0.78...1.5)U _N	(0.78...1.5)U _N
Holding voltage	AC/DC	—/0.4 U _N	—/0.4 U _N
Must drop-out voltage	AC/DC	—/0.1 U _N	—/0.1 U _N

Technical data

Mechanical life AC/DC	cycles	—/20 · 10 ⁶	—/20 · 10 ⁶
Electrical life at rated load AC1	cycles	50 · 10 ³	50 · 10 ³
Operate/release time	ms	6/4	6/2
Insulation between coil and contacts (1.2/50 μs)	kV	5	5
Dielectric strength between open contacts	V AC	1000	1000
Ambient temperature range	°C	-40...+85	-40...+85
Environmental protection		RT III	RT III

Approvals (according to type)



Ordering information

Example: 32 series PCB, 1 NO (SPDT-NO) - 6 A contacts, 24 V sensitive DC coil.

A

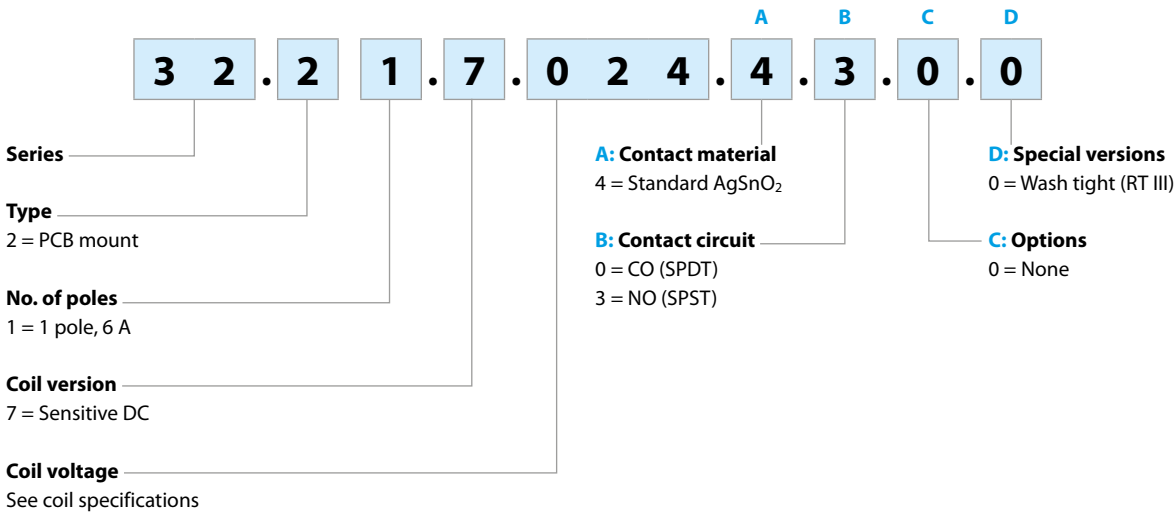

Selecting features and options: only combinations in the same row are possible.

Preferred selections for best availability are shown in **bold**.

Type	Coil version	A	B	C	D
32.21	sens. DC	4	0 - 3	0	0

Technical data

Insulation according to EN 61810-1

Nominal voltage of supply system	V AC	230/400
Rated insulation voltage	V AC	250
Pollution degree		2

Insulation between coil and contact set

Type of insulation		Basic
Overvoltage category		III
Rated impulse voltage	kV (1.2/50 µs)	5
Dielectric strength	V AC	4000

Insulation between open contacts

Type of disconnection		Micro-disconnection
Dielectric strength	V AC/kV (1.2/50 µs)	1000/1.5

Insulation between coil terminals

Rated impulse voltage (surge) differential mode (according to EN 61000-4-5)	kV (1.2/50 µs)	2
---	----------------	---

Other data

Bounce time: NO/NC	ms	2/10 (changeover)	2/— (normally open)
Vibration resistance (5...55)Hz: NO/NC	g	10/10 (changeover)	10/— (normally open)
Shock resistance	g	20	
Power lost to the environment	without contact current	W	0.2
	with rated current	W	0.5
Recommended distance between relays mounted on PCB	mm	≥ 5	

Contact specification

F 32 - Electrical life (AC) v contact current

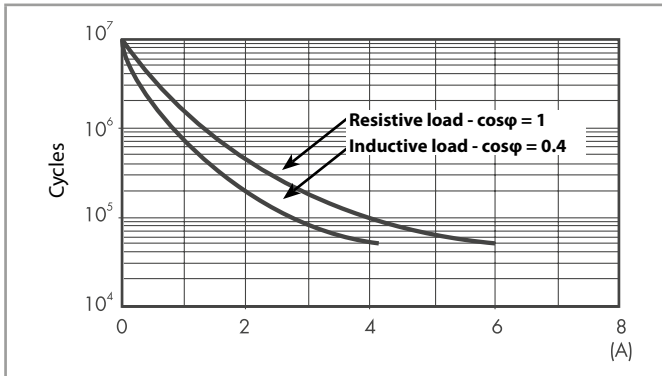

H 32 - Maximum DC1 breaking capacity

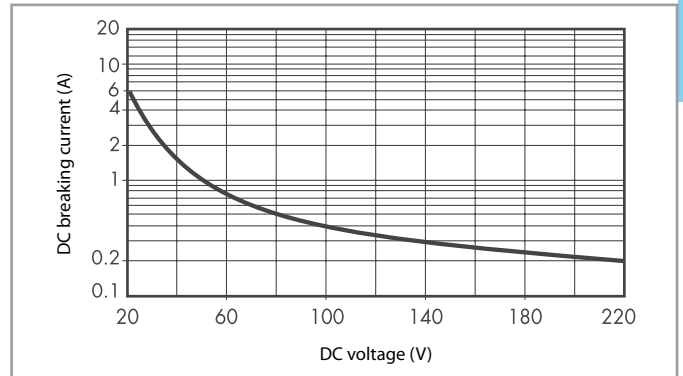

- When switching a resistive load (DC1) having voltage and current values under the curve, an electrical life of $\geq 50 \cdot 10^3$ can be expected.
 - In the case of DC13 loads, the connection of a diode in parallel with the load will permit a similar electrical life as for a DC1 load.
- Note: the release time for the load will be increased.

Coil specifications

DC coil data - 0.2 W sensitive

Nominal voltage U_N V	Coil code	Operating range		Resistance R Ω	Rated coil consumption I at U_N mA
		U_{min} V	U_{max} V		
5	7.005	3.9	7.5	125	40
12	7.012	9.4	18	720	16
24	7.024	18.7	36	2880	8.3
48	7.048	37.4	72	11520	4

R 32 - DC coil operating range v ambient temperature

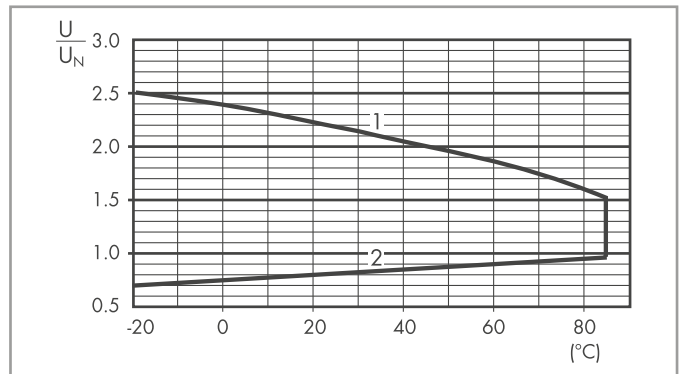

- 1 - Max. permitted coil voltage.
- 2 - Min. pick-up voltage with coil at ambient temperature.

Outline drawing

Types 32.21-4000/4300

