

Modular step relays 16 A



Automation for
blinds, grilles
and shutters



Living room
light control



Bedroom
light control



Lighting control
in corridors (for
hotels, offices
and hospitals)



20
SERIES

1 or 2 Pole 16 A Step relays for direct 35 mm rail (EN 60715) mounting

- 17.4 mm wide
- Test button with mechanical indicators
- Choice of 7 switching sequences
- AC coils and DC coils
- Identification label
- According to EN 60601-1 2 x MOPP
- Possible to connect illuminated push buttons with the additional part 026.00
- 35 mm rail (EN 60715) mount
- Cadmium free contact material

20.21/22/24/26/27/28/23
Screw terminal



FOR UL RATINGS SEE:
"General technical information" page V

For outline drawing see page 5

Contact specification

Contact configuration	1 NO (SPST-NO)	2 NO (DPST-NO)	1NO+1NC (SPST-NO+SPST-NC)
Rated current/Maximum peak current	A 16/30	16/30	16/30
Rated voltage/ Maximum switching voltage	V AC 250/400	250/400	250/400
Rated load AC1	VA 4000	4000	4000
Rated load AC15 (230 V AC)	VA 750	750	750
Nominal lamp rating:			
230 V incandescent/halogen W	2000	2000	2000
fluorescent tubes with electronic ballast W	1000	1000	1000
fluorescent tubes with electromagnetic ballast W	750	750	750
CFL W	400	400	400
230 V LED W	400	400	400
LV halogen or LED with electronic ballast W	400	400	400
LV halogen or LED with electromagnetic ballast W	800	800	800
Minimum switching load	mW (V/mA) 1000 (10/10)	1000 (10/10)	1000 (10/10)
Standard contact material	AgSnO ₂	AgSnO ₂	AgSnO ₂

Coil specification

Nominal voltage (U _N)	V AC (50/60 Hz)	8 - 12 - 24 - 48 - 110 - 120 - 230 - 240	
	V DC	12 - 24 - 48 - 110	12 - 24 - 48 - 110
Rated power AC/DC	VA (50 Hz)/W	6.5/5	6.5/5
Operating range	AC	(0.85...1.1)U _N (50 Hz)/(0.9...1.1)U _N (60 Hz)	
	DC	(0.9...1.1)U _N	(0.9...1.1)U _N

Technical data

Mechanical life AC/DC	cycles	300 · 10 ³	300 · 10 ³	300 · 10 ³
Electrical life at rated load in AC1	cycles	100 · 10 ³	100 · 10 ³	100 · 10 ³
Minimum/Maximum impulse duration		0.1 s/1 h (according to EN 60669)	0.1 s/1 h (according to EN 60669)	0.1 s/1 h (according to EN 60669)
Insulation between coil and contacts (1.2/50 μs)	kV	4	4	4
Ambient temperature range	°C	-40...+40	-40...+40	-40...+40
Protection category		IP 20	IP 20	IP 20

Approvals (according to type)



Ordering information

Example: 20 series relay, 35 mm rail (EN 60715) mount, double phase switch, 2 NO 16 A contacts, coil rated at 12 V DC, AgSnO₂ contacts.

2 0 . 2 2 . 9 . 0 1 2 . 4 0 0 0

Series
Type

2 = 35 mm rail (EN 60715) mount

No. of poles

- 1 = Single phase switch 1 NO (SPST-NO)
- 2 = Double phase switch 2 NO (DPST-NO)
- 3 = Double phase switch 1 NC+ 1 NO (SPST-NO+SPST-NC)
- 4 = 4 sequence double phase switch 2 NO (DPST-NO)
- 6 = 3 sequence double phase switch 2 NO (DPST-NO)
- 7 = 3 sequence double phase switch 2 NO (DPST-NO)
- 8 = 4 sequence double phase switch 2 NO (DPST-NO)

Contact material

- 0 = AgNi
- 4 = AgSnO₂

Coil voltage

See coil specifications

Coil version

- 8 = AC (50/60 Hz)
- 9 = DC

Technical data

Insulation

Dielectric strength		
between supply and contacts	V AC	4000
between open contacts	V AC	2000
between adjacent contacts	V AC	2000

Other data

Power lost to the environment					
with rated current and coil deenergised	W	1.3 (20.21, 20.23, 20.28)	2.6 (20.22, 20.24, 20.26, 20.27)		
 Screw torque	Nm	0.8	0.8		
Max. wire size		Coil terminals		Contact terminals	
		solid cable	stranded cable	solid cable	stranded cable
	mm ²	1 x 4 / 2 x 2.5	1 x 2.5 / 2 x 2.5	1 x 6 / 2 x 4	1 x 4 / 2 x 2.5
	AWG	1 x 12 / 2 x 14	1 x 14 / 2 x 14	1 x 10 / 2 x 12	1 x 12 / 2 x 14

If the coil is operated for a prolonged period of time, adequate ventilation of the relays must be provided - suggested gap of 9 mm between adjacent relays.





















Coil specifications

DC version data

Nominal voltage U _N	Coil code	Operating range		Resistance R	Consumption I at U _N
		U _{min}	U _{max}		
V		V	V	Ω	mA
12	9.012	10.8	13.2	27	440
24	9.024	21.6	26.4	105	230
48	9.048	43.2	52.8	440	110
110	9.110	99	121	2330	47

AC version data

Nominal voltage U _N	Coil code	Operating range		Resistance R	Consumption I at U _N (50 Hz)
		U _{min}	U _{max}		
V		V	V	Ω	mA
8	8.008	6.8	8.8	4	800
12	8.012	10.2	13.2	7.5	550
24	8.024	20.4	26.4	27	275
48	8.048	40.8	52.8	106	150
110	8.110	93.5	121	590	64
120	8.120	102	132	680	54
230	8.230	192	253	2500	28
240	8.240	204	264	2700	27.5

Type	Number of steps	Sequence			
		1	2	3	4
20.21	2				
20.22	2				
20.23	2				
20.24	4				
20.26	3				
20.27	3				
20.28	4				

Wiring diagrams

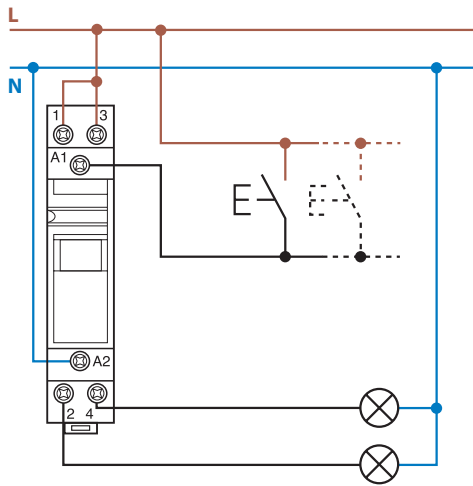

Example: 230 V AC supply voltage.

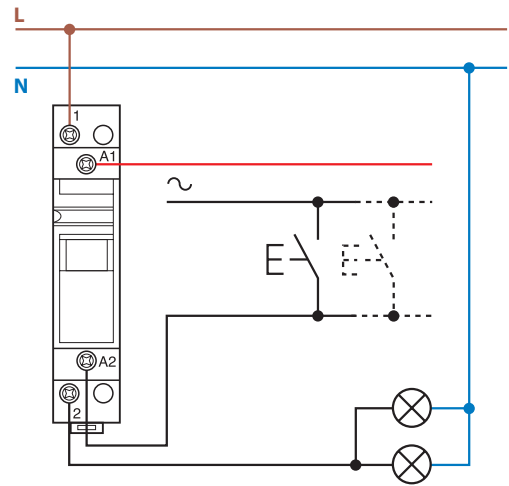

Example: 24 V AC supply voltage.

Outline drawings

Type 20.21
Screw terminal

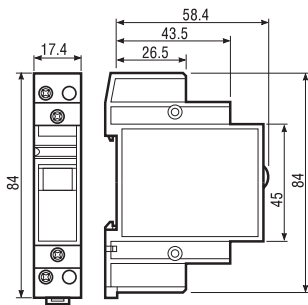

Types 20.22/24/26/27/28
Screw terminal

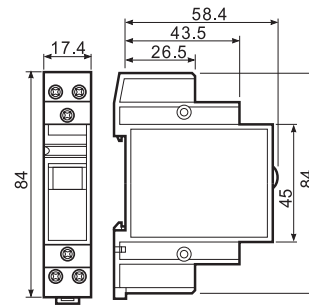

Type 20.23
Screw terminal

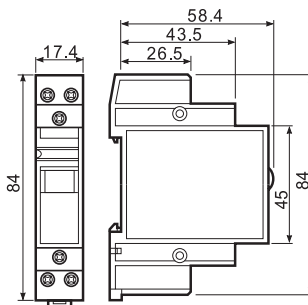

Accessories

Module for use with illuminated push-buttons

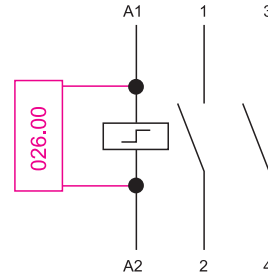
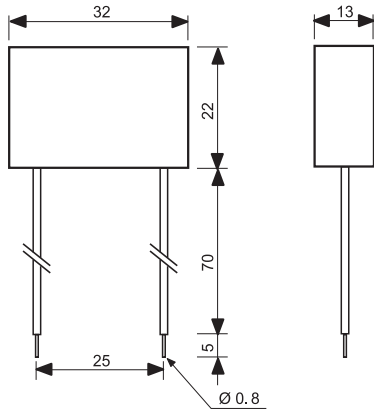

Type 026.00

Sealed construction, 7.5 cm insulated flexible wire termination.

Example of wiring diagram of type 026.00

This module is necessary when using between 1 and a maximum of 15 illuminated push buttons in the coil circuit (Each 1.5 mA max, 230 V AC). It must be connected in parallel to the coil of the relay.



020.01

Adaptor for panel mounting, 17.5 mm wide

020.01



022.09

Separator for rail mounting, plastic, 9 mm wide

022.09

