

Serie RB
Relè bistabile



Relè bistabili di comando e di segnalazione

Tipo RB.14 - Modulare, montaggio su barra 35 mm
Tipo RB.22 - Innesto su zoccolo undecal

Per impieghi in ambito energetico e ferroviario

- Tipo RB.14: 4 contatti in scambio 8 A, modulare, montaggio su barra 35 mm (EN 60715)
- Tipo RB.22: 2 contatti in scambio 8 A, innesto su zoccolo undecal Tipo 90.21
- Tensioni di alimentazione nominali: 24 - 110...125 - 220...250 V DC
- Versione con doppia bobina
- Comandi di SET e RESET manuali sul prodotto o remotabili
- Indicatore LED verde/rosso per lo stato dei comandi (SET e RESET)

Omologazioni



Relè bistabili di comando e di segnalazione

Tipo RB.14.9.xxx.0000
4 contatti in scambio 8 A,
modulare, montaggio
su barra 35 mm (EN 60715)

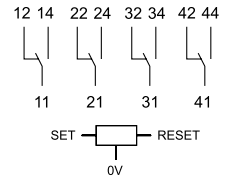
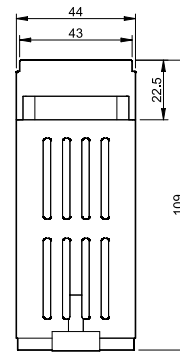
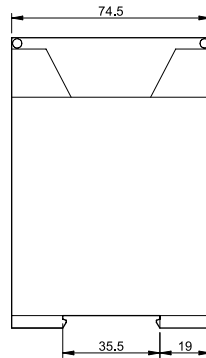

Collegamento con solo i pulsanti
a bordo abilitati
EN = positivo
0V = negativo

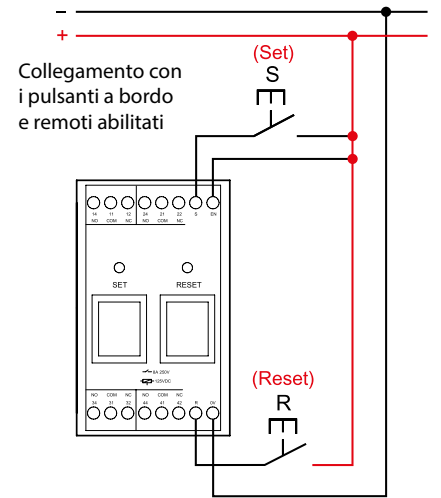
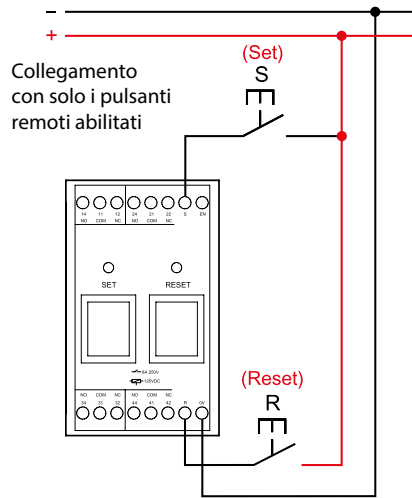
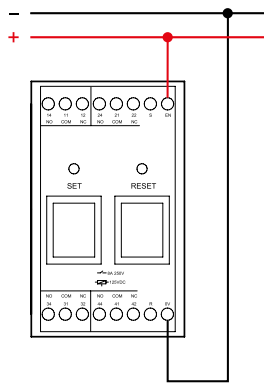

Tipo RB.22.9.xxx.9021
2 contatti in scambio 8 A,
innesto su zoccolo undecal
Tipo 90.21, con morsetti a
bussola

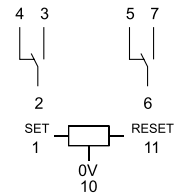
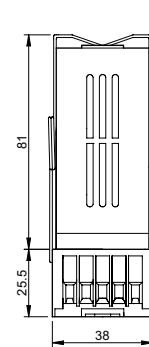
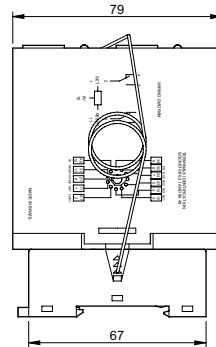

Collegamento con
solo i pulsanti a
bordo abilitati
EN = positivo
0V = negativo

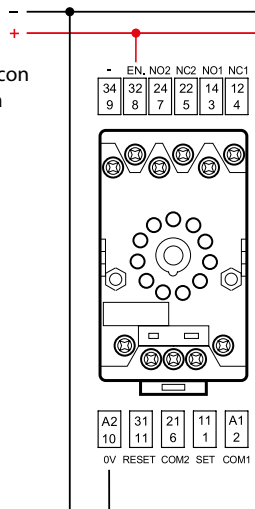

Collegamento con solo i pulsanti remoti abilitati

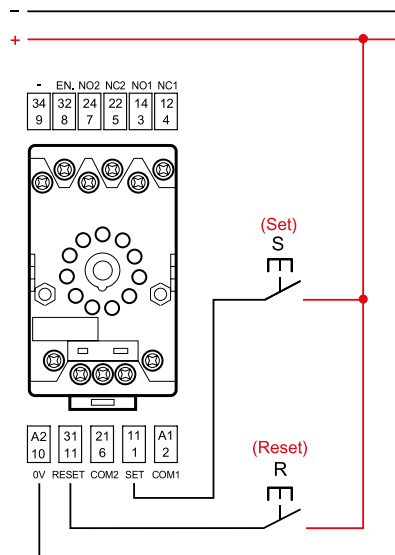

Collegamento con i pulsanti a bordo e remoti abilitati

