

Série RB
Relais bistables



Relais bistables de commande et de signalisation
Type RB.14 - Modulaire, montage sur rail 35 mm (EN 60715)
Type RB.22 - Montage sur support undecal type 90.21

Pour les applications ferroviaires et dans le domaine de l'énergie

- Type RB.14 : 4 contacts inverseurs 8 A, modulaire, montage sur rail 35 mm (EN 60715)
- Type RB.22 : 2 contacts inverseurs 8 A, base undecale (11 broches) montage sur support 90.21
- Tension d'alimentation nominal : 24 - 110...125 - 220...250 V DC
- Version double bobine
- Commandes de SET et RESET manuelle ou à distance
- Indication LED verte/rouge pour la signalisation de l'état des commandes (SET/RESET)

Homologations



Relais bistables de commande et de signalisation

Type RB.14.9.xxx.0000
4 contacts inverseurs 8 A,
modulaire, montage sur
rail 35 mm (EN 60715)

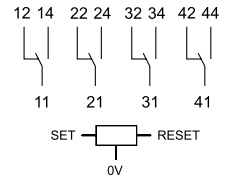
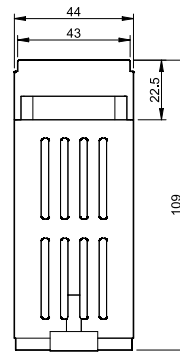
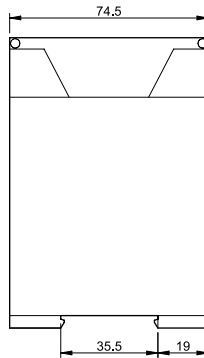

Raccordement avec boutons
en façade actifs
EN = Actif - Tension positive
0 V = Tension négative

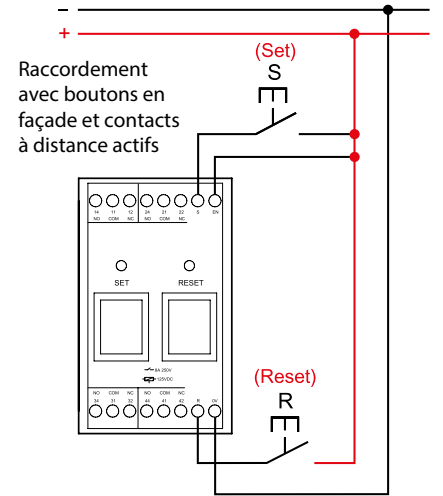
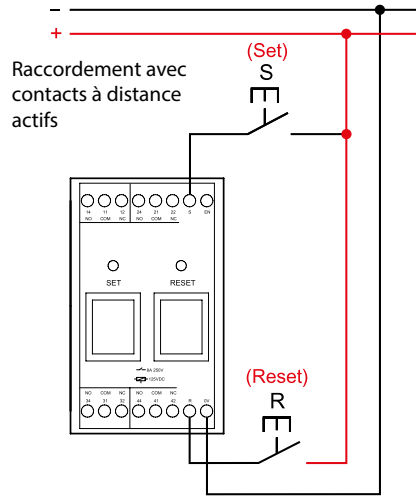
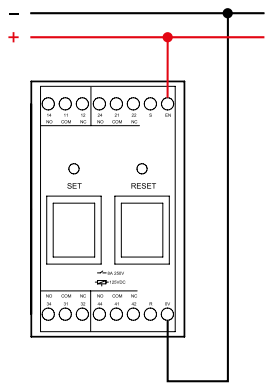

Type RB.22.9.xxx.9021
2 contacts inverseurs 8 A,
base undecale (11 broches)
montage sur support 90.21
(avec bornes à cage)

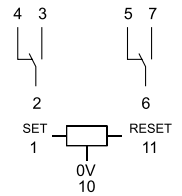
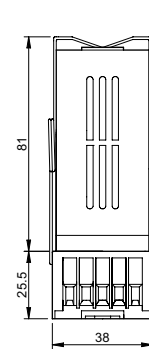
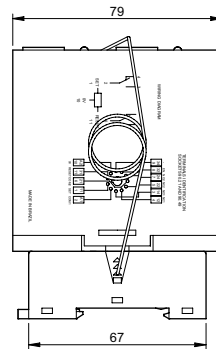

Raccordement avec boutons en façade actifs
EN = Actif - Tension positive
0 V = Tension négative

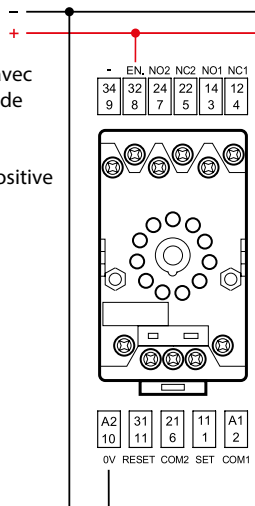

Raccordement avec contacts à distance actifs

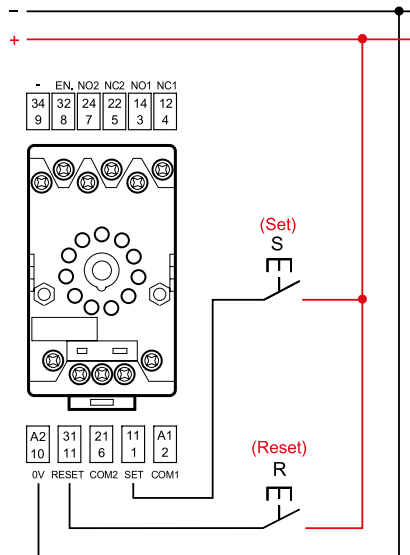

Raccordement avec boutons en façade et contacts à distance actifs

