







13.71

	<b>13.71.8.230.0000</b> $U_N$ 230 V AC (50/60 Hz) $U_{min}$ 195.5 V AC $U_{max}$ 264.5 V AC
	1 NO (SPST-NO) 10 A 230 V AC $\mu$  (230 V AC) 1000 W  (230 V AC) 350 W
	(-10...+60)°C
IP20	
	15 (1.0 mA)

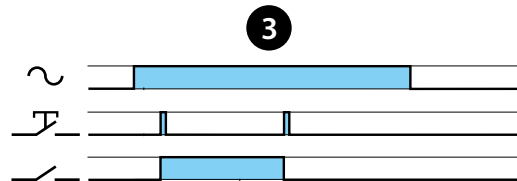
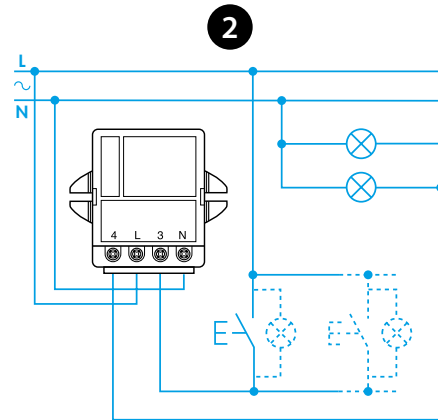
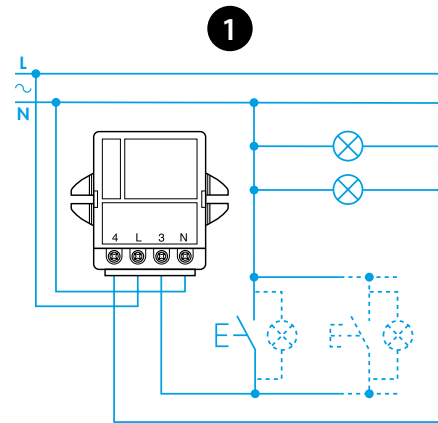
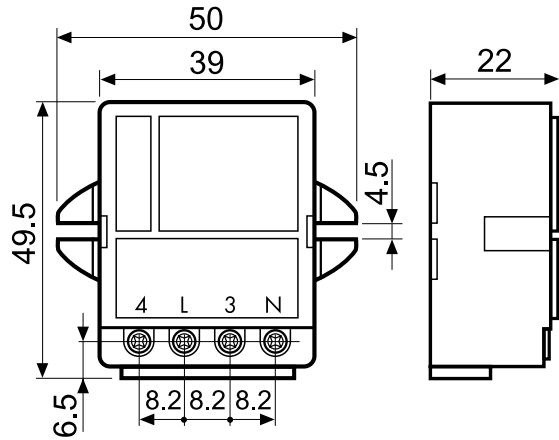

# DEUTSCH

## 13.71 ELEKTRONISCHER STROMSTOSS-SCHALTER

- 1** 3 - LEITER - SCHALTUNG
- 2** 4 - LEITER - SCHALTUNG
- 3** FUNKTION  
RI - Stromstoss-Relais-Funktion / Stromstoss-Schalter-Funktion

ANMERKUNG  
HINWEIS: Befestigung mit 2 Schrauben M4